



FOOTBALL  
SELECTION 2026-2027



|           |                                                                    |           |                                                        |
|-----------|--------------------------------------------------------------------|-----------|--------------------------------------------------------|
| <b>3</b>  | <b>REBOUND BOARD</b><br>P.3                                        | <b>30</b> | <b>REFEREEING</b><br>P.30                              |
| <b>4</b>  | <b>TRAINING GOALS<br/>AND MINI GOALS</b><br>P.4                    | <b>34</b> | <b>COACH</b><br>P.34                                   |
| <b>11</b> | <b>FOOTBALL AND FUTSAL<br/>TARGETS</b><br>P.11                     | <b>41</b> | <b>FIRST AID</b><br>P.41                               |
| <b>12</b> | <b>BALL TENNIS SETS / FUTNET KIT /<br/>MINI TENNIS KIT</b><br>P.12 | <b>48</b> | <b>BOTTLES AND BOTTLE CARRIERS</b><br>P.48             |
| <b>13</b> | <b>TRAINING</b><br>P.13                                            | <b>50</b> | <b>TRACING, FIELD AND<br/>NETS ACCESSORIES</b><br>P.50 |
| <b>24</b> | <b>MUSCULE STRENGTHENING</b><br>P.24                               | <b>53</b> | <b>NETS</b><br>P.56                                    |
| <b>27</b> | <b>STOPWATCHES</b><br>P.27                                         | <b>56</b> | <b>STORAGE AND TRANSPORT</b><br>P.56                   |
| <b>28</b> | <b>PLAYER'S EQUIPMENT</b><br>P.28                                  | <b>58</b> | <b>BALLS AND INFLATING</b><br>P.58                     |

# REBOUND BOARD

## FOLDABLE REBOUND BOARD

**S** SPORTI

2026  
NEW



| WEIGHT  | DEPTH  | WIDTH | HEIGHT |
|---------|--------|-------|--------|
| 11.8 kg | 100 cm | 40 cm | 40 cm  |

Ideal for practising and perfecting technical skills. Makes ground passing drills easier and ensures excellent stability thanks to its side reinforcements. Folds easily and is easy to carry thanks to its handle. Can be used in two positions: flat or inclined for volley training.

Reference: 064126

Unit

## • REBOUND BOARD « *L'Originale* »

**S** SPORTI



« *L'Originale* » IN 4 KEY WORDS:

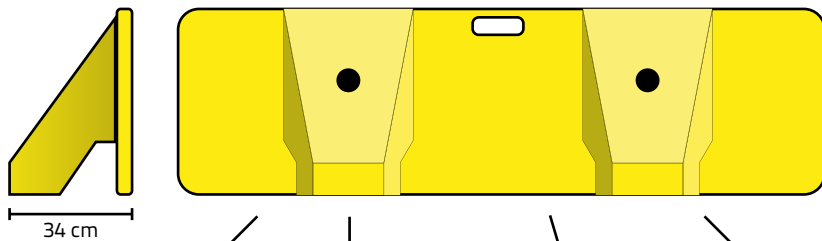

**HANDY AND STABLE**  
One-piece design and optimum distribution of the ballast weight

**CONTACT SURFACE**  
Perfect flat, proven filling process

**DURABLE**  
Quality of selected materials and French know-how

**VERSATILE**  
Multiple possible positions



Already used by numerous European and French professional clubs and federations as well.



+ Easy transport



| WEIGHT | LENGTH | WIDTH | HEIGHT |
|--------|--------|-------|--------|
| 23 kg  | 180 cm | 34 cm | 50 cm  |

«L'Originale» The tried-and-tested soccer rebound board reproduces the natural qualities of a pass or a shot due to its weighted base, its balance and its durable components. The rebound board offers unlimited possibilities for your passing & sequence exercises, kickbacks and shots. On your own or in a group, it can be used as a one-two lane, a shooting target, a relay or even as a mini-goal. Fun and easy, it is also appreciated by the youngest in the conception of circuits. Highly-resistant and ultra-durable materials, the components have been all selected for their reliability and high responsiveness.

Specific attention has been paid to the long-term flatness of the contact surface and the quality of the rebound. In addition, the distribution of the ballast weight gives excellent stability and perfect balance even under the most powerful shots.

Reference: 064118

Yellow

Reference: 064119

Red



FOLDING ALUMINIUM MINI GOAL ELITE



+ Foldable in a few seconds



2026 NEW new colours new size 120 cm

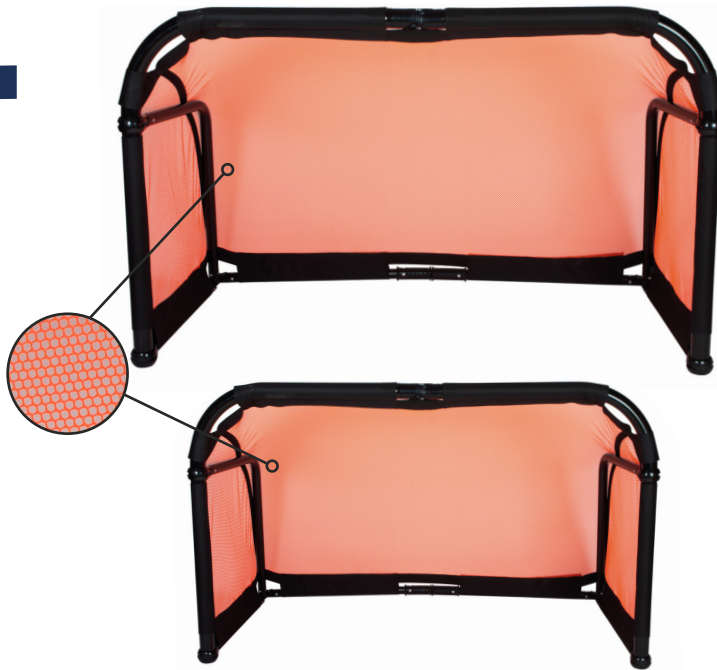

+ Foldable in a few seconds



|    |        |        |
|----|--------|--------|
|    | 064247 | 064248 |
|    |        |        |
| L. | 120 cm | 155 cm |
| H. | 80 cm  | 95 cm  |
| D. | 60 cm  | 75 cm  |

|          |        |        |
|----------|--------|--------|
|          | 064247 | 064248 |
| Tube     | WEIGHT | WEIGHT |
| Ø 5.0 cm | 7.5 kg | 8.1 kg |

Assembled in 15 seconds and 3 movements. Very compact, very robust and light. Supplied with very resistant and high visibility honeycomb net. Net delivered assembled. Easy transportation. Indoor and outdoor use. Available in 2 dimensions and 3 colours: Blue, Neon yellow and neon orange.

- Reference: 064247 Goal 120 x 80 x 60 cm.
- Reference: 064247F Spare net for ref 064247
- Reference: 064248 Goal 155 X 95 X 75 cm.
- Reference: 064248F Spare net for ref 064248

• SELF-WEIGHTED AND FOLDING ALUMINIUM MINI GOAL



+ 2 sizes available

|    |        |
|----|--------|
|    | 064064 |
|    |        |
| L. | 120 cm |
| H. | 90 cm  |
| D. | 70 cm  |

|    |        |
|----|--------|
|    | 064065 |
|    |        |
| L. | 155 cm |
| H. | 95 cm  |
| D. | 80 cm  |

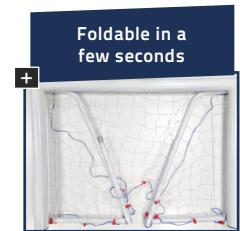

+ Foldable in a few seconds



Quick folding without tools

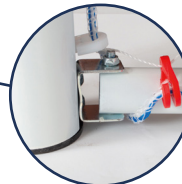

|        |        |        |
|--------|--------|--------|
|        | 064065 | 064064 |
| WEIGHT | 17 kg  | 16 kg  |



Mini goal combining robustness of an aluminium goal, stability of a self-weighted goal and convenience of a folding goal. Its 80 mm section aluminium frame and its 32 and 38 mm self-weighted rear structure make it a very stable goal for safe practice. Foldable in a few seconds, it's easy to transport, store and it's not bulky. The net (white twisted PE 2.5 mm, single mesh 70 mm knotted) is easily installed thanks to the clips on the frame and the split rings. Pegs in "U" shape included. Sold individually.

- Reference: 064064 Goal 120 x 90 x 70 cm
- Reference: 064064F Spare net + red hooks
- Reference: 060030 White net hook for goal - Unit
- Reference: 060036 Set of 12 red hooks for mini goal
- Reference: 064065 Goal 155 x 95 x 80 cm
- Reference: 064065F Spare net + red hooks



• SELF-WEIGHTED ALUMINIUM MINI GOAL



Possibility to use a weighted base 063344

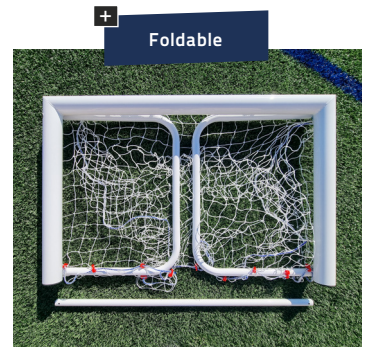

|        |        |
|--------|--------|
| 064232 |        |
| L.     | 120 cm |
| H.     | 80 cm  |
| D.     | 60 cm  |

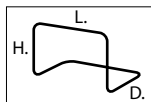

|        |        |
|--------|--------|
| 064013 |        |
| L.     | 150 cm |
| H.     | 100 cm |
| D.     | 70 cm  |



Round tube frame of 80 mm and foldable rear support tube of 38 mm to facilitate its transport and storage. The net (2.5 mm twisted PE green, simple mesh 70 mm with knots) is very easy to install thanks to the clips on the frame and to the split rings delivered with pegs in U shape. It is self-weighted, therefore it brings it a lot of robustness, stability and security. Sold by the unit.

Reference: 064232 Goal L. 120 x 80 x 60 cm. - 15.5 kg

Reference: 064232F Spare net + Red goal net hook

Reference: 064013 Goal L. 150 x 100 x 70 cm. - 19 kg

Reference: 064013F Spare net + Red goal net hook

Reference: 060030

White sliding hook for goal - per unit

Reference: 060036

Set of 12 red goal net hook for mini goal

• REVERSIBLE FIXED MINI GOAL 120CM



2 goals = 4 sizes!



|        |        |
|--------|--------|
| 064067 |        |
|        |        |
| L.     | 150 cm |
| H.     | 100 cm |
| D.     | 70 cm  |



REVERSIBLE



|        |        |
|--------|--------|
| 064067 |        |
|        |        |
| L.     | 150 cm |
| H.     | 70 cm  |
| D.     | 100 cm |

|        |        |
|--------|--------|
| 064066 |        |
|        |        |
| L.     | 120 cm |
| H.     | 80 cm  |
| D.     | 60 cm  |



REVERSIBLE



|        |        |
|--------|--------|
| 064066 |        |
|        |        |
| L.     | 120 cm |
| H.     | 60 cm  |
| D.     | 80 cm  |

Do the choice of robustness and adaptability with this REVERSIBLE goal. Flip it over to get a different goal height, depending on what you want to work on. White aluminum frame with an 80 mm cross-section and rear hoops with a 38 mm cross-section. Equipped with a PE net with 4mm knots and 7 x 7cm mesh. Supplied with the hooks and screws necessary (34 hooks for 120 cm and 40 for the 150 cm).

Reference: 064066

Goal L.120 x H.80 x D.60 cm - W.14kg

Reference: 064066F

Spare net + hooks for ref 064066

Reference: 064067

Goal L.150 x H.100 x D.70 cm - W.17kg

Reference: 064067F

Spare net + hooks for ref 064067

Reference: 060052

Set of 40 hooks



ALUMINIUM FOLDING MINI GOAL



Foldable in a few seconds +

| Dimensions |        |
|------------|--------|
| L.         | 155 cm |
| H.         | 95 cm  |
| D.         | 75 cm  |



| Dimensions |        |
|------------|--------|
| L.         | 120 cm |
| H.         | 80 cm  |
| D.         | 60 cm  |



| Tube |        |
|------|--------|
| Ø    | 3.8 cm |

You can assemble it in 15 seconds and 3 movements. It has a compact design, is robust and light. Delivered with a honeycombed net. Easy transport. For better stability, it is recommended to use a weighted base (Reference 063344).

|                     |                                     |      |
|---------------------|-------------------------------------|------|
| Reference: 064211   | Goal 120 x 80 x 60 cm / W. 8.5 kg.  | Unit |
| Reference: 064211NF | Spare net 120 x 80 x 60 cm          | Unit |
| Reference: 064213   | Goal 155 x 95 x 75 cm / W. 10.5 kg. | Unit |
| Reference: 064213F  | Spare net 155 x 95 x 75 cm          | Unit |

«POP UP» FOLDING RECTANGLE MINI GOAL (PAIR)



Delivered with a carrying bag +



Available in 2 sizes +



Pop up folding mini goals pair. It folds up and folds down very quickly. Easy to fold and to carry due to its carrying bag.

|                   |                            |
|-------------------|----------------------------|
| Reference: 064203 | 120 x 90 x 90 cm. - Pair   |
| Reference: 064204 | 180 x 120 x 120 cm. - Pair |



**STEEL FOLDING MINI GOAL**

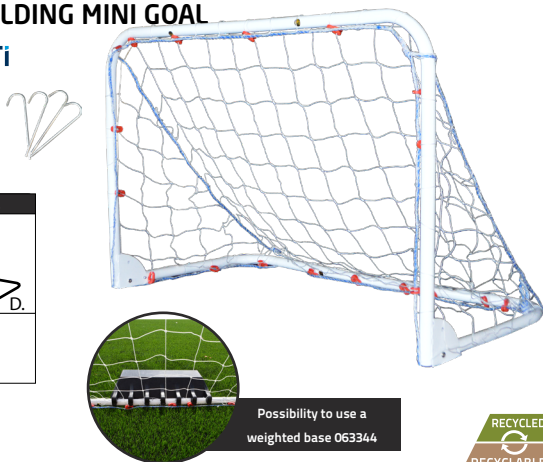

| Dimensions |        |
|------------|--------|
| L.         | 120 cm |
| H.         | 80 cm  |
| D.         | 60 cm  |

| Tube |        |
|------|--------|
| Ø    | 3.2 cm |



Possibility to use a weighted base 063344



Metal structure. Very practical due to its compact design when folded. Delivered with its net (white, 2 mm twisted PE, simple mesh 100 mm with knot) and pegs.

Reference: 064205U Unit  
 Reference: 064205U From 2  
 Reference: 064205F Spare net + Red hooks

**TWO-IN-ONE WEIGHTED BASE FOR GOALS AND DUMMIES**



| Base     | For tube    |
|----------|-------------|
| W. 12 Kg | Ø max: 40mm |

| LENGTH | WIDTH | HEIGHT  |
|--------|-------|---------|
| 50 cm  | 32 cm | 11.2 cm |

Claws on one base side allowing to weight mini goals and thus avoid their toppling. It is made in such a way that claws are put on the bar which is behind mini goals. It is compatible with all mini goals with tube diameter until 40mm. One base is enough for a mini goal. It also allows to hold dummies in place on smooth or synthetic surfaces due to all holes which are on the top of the base. Colour: Black.

Reference: 063344 Unit

**REVERSIBLE MINI GOAL 90 x 70 x 56 CM**

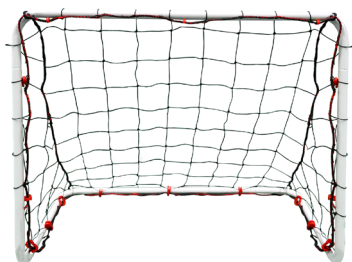

Possibility to use a weighted base 063344

| Tube |        |
|------|--------|
| Ø    | 2.5 cm |

| WIDTH | HEIGHT | DEPTH |
|-------|--------|-------|
| 90 cm | 70 cm  | 56 cm |

Metal structure. Delivered with net (black, 2mm twisted PE, simple mesh 100mm with knot), 4 pegs and instructions for an easy assembly. This goal is reversible and not foldable.

Reference: 064129 Unit  
 Reference: 064129F Spare net + Red hooks

**REVERSIBLE MINI GOAL 120 x 90 x 60 CM**

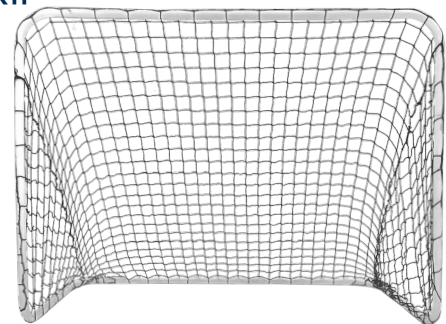

| Tube |        |
|------|--------|
| Ø    | 2.5 cm |

| WIDTH  | HEIGHT | DEPTH |
|--------|--------|-------|
| 120 cm | 90 cm  | 60 cm |

Metal structure. Delivered with net (black, 3mm braided PP, simple mesh 45mm without knot), pegs and instructions for an easy assembly. This goal is reversible and not foldable.

Reference: 064214 Unit  
 Reference: 064214F Spare net

**REVERSIBLE MINI GOAL 200 x 130 x 90 CM**

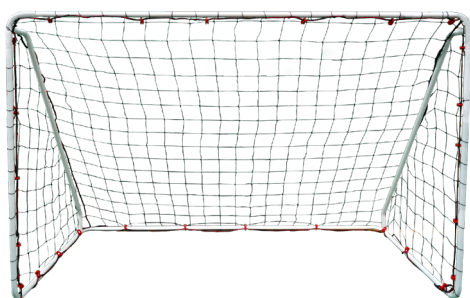

Possibility to use a weighted base 063344

| Tube |        |
|------|--------|
| Ø    | 2.5 cm |

| WIDTH  | HEIGHT | DEPTH |
|--------|--------|-------|
| 200 cm | 130 cm | 90 cm |



Metal structure. Delivered with net (black, 2 mm twisted PE, simple mesh 100 mm with knot), 6 pegs and instructions for an easy assembly. This goal is reversible and not foldable. 2 reinforcement bars at the back.

Reference: 064130 Unit  
 Reference: 064130F Spare net + Red hooks

**REVERSIBLE MINI GOAL 300 x 200 x 120 CM**

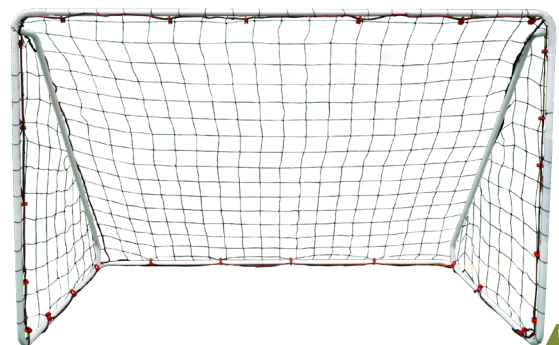

| Tube |        |
|------|--------|
| Ø    | 2.5 cm |

| WIDTH  | HEIGHT | DEPTH  |
|--------|--------|--------|
| 300 cm | 200 cm | 120 cm |



Reference: 064131 Unit  
 Reference: 064131F Spare net + Red hooks

FOLDABLE FUTSAL FLEXI-GOAL®



Self-weighted structure +



Assembly in 2 minutes +



Delivered with a carrying bag +

RECYCLED  
RECYCLABLE  
WIDTH 3 m  
HEIGHT 2 m

This self-weighted goal is specially designed for futsal. It can be mounted and dismantled in 2 minutes. Light and resistant steel structure. Easy to carry. Delivered with a carrying bag. Non-skid pads under goal base to protect indoor ground. White polyester net 2.4 mm knotless, 5 x 5 cm mesh. Dimensions: 3 x 2 m, 1 m depth.

Reference: 064442

Goal 3 x 2 x 1 m

Unit



FLEXI-GOAL® FOLDABLE FOOTBALL GOALS



Structure self-weighted +

3 sizes: 2.40 x 1.20m / 3.60 x 1.80m / 4 x 1.5m



Assembly in 2 minutes +

DISCOVER IN VIDEO



This goal can be used on all ground types (grass, synthetic and hard grounds, etc.). It can be assembled and disassembled in 2 minutes. Light and resistant steel structure. Easy to carry. Delivered with a carrying bag, 4 pegs in 'U' shape included. Non-skid pads under goal base to protect indoor ground.

|                   |                               |      |
|-------------------|-------------------------------|------|
| Reference: 064439 | Goal 2.40 x 1.20m, depth 0.7m | Unit |
| Reference: 064438 | Goal 3.60 x 1.80m, depth 1m   | Unit |
| Reference: 064437 | Goal 4 x 1.50m, depth 1m      | Unit |





• FOLDABLE GOAL «SECURE»



Delivered with a carrying bag +

Assembly in 2 minutes +

DISCOVER IN VIDEO 

RECYCLED RECYCLABLE 

Dimensions

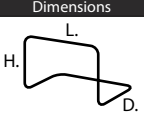
|                                                                                  |    |    |
|----------------------------------------------------------------------------------|----|----|
| L.                                                                               | H. | D. |
|  |    |    |

This new concept of multisport folding goal is assembled and disassembled in 2 minutes, light and resistant. Fixing pegs included. Easy to transport. Supplied with a carry bag.

|                   |                              |      |
|-------------------|------------------------------|------|
| Reference: 064167 | L. 182 x H. 121 x D. 70 cm.  | Unit |
| Reference: 064168 | L. 244 x H. 152 x D. 80 cm.  | Unit |
| Reference: 064169 | L. 300 x H. 200 x D. 100 cm. | Unit |

• PVC FOLDING GOAL 4 X 1.50 M



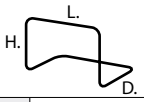

Dimensions

|                                                                                    |        |    |
|------------------------------------------------------------------------------------|--------|----|
| L.                                                                                 | H.     | D. |
|  |        |    |
| L.                                                                                 | 400 cm |    |
| H.                                                                                 | 150 cm |    |
| D.                                                                                 | 135 cm |    |

Tube

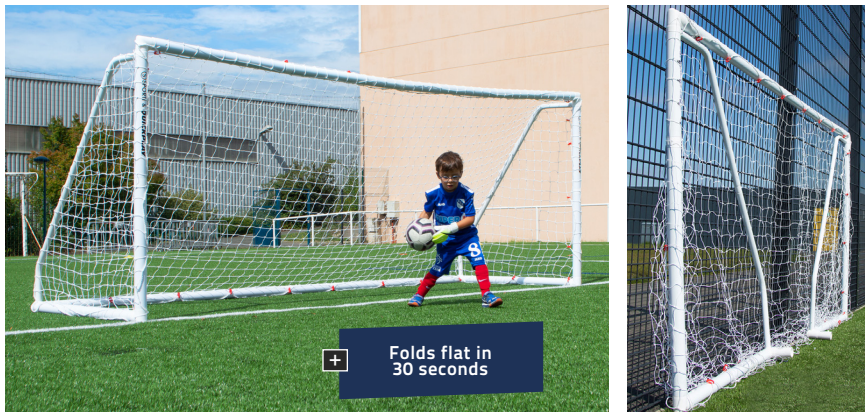
|   |      |
|---|------|
| Ø | 7 cm |
|---|------|



All weather uPVC heavy duty 

Patented fold /lock system 

UPVC goal very resistant and flexible in 4 x 1.5 m. Easily adjustable in 3x1.5m. Tubes diameter: 70 mm. Perfect for trainings and matches of U6 and U9 categories as well as for your tournaments. Easy to carry. Foldable: it becomes entirely flat in 30 seconds which facilitates its storage against a wall. Thanks to the tubes locking by clip system (seals locking) the goal is very well kept. Delivered with a white net 2.5 mm twisted PE. Simple mesh 85 mm knotted. Easy to set up due to the split rings supplied. Delivered with pegs in U shape. UPVC structure of the goal is guaranteed 2 years.

|                    |                |      |
|--------------------|----------------|------|
| Reference: 064103  | Goal 4 x 1.5 m | Unit |
| Reference: 064103F | Spare net      | Unit |

BALLASTED BAG FOR GOAL



Polyester bag to ballast (maximum capacity of 20 kg.) allowing to secure goals and mini goals. Easy handling with a large handle.

|                   |      |
|-------------------|------|
| Reference: 064044 | Unit |
|-------------------|------|



TARGET FOR FOOTBALL GOAL

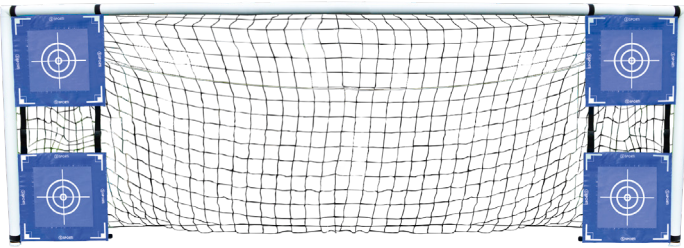

Demonstration on a folding 8-goal

Adjustable height = fits on goal at 8 and 11



Delivered with 2 pegs



Supplied with a carrying bag



| Target   | Support  |
|----------|----------|
| L. 60 cm | L. 74 cm |
| w. 60 cm | w. 74 cm |

Made in coating polyester tarpaulin very resistant and easy to install due to its hook and loop system, this set of 4 adjustable targets (2x2) can be set up on football goals for 8 (6 x 2.1m) or for 11 (7.32 x 2.44m) due to adjustables straps. It can be your ideal partner for your penalty sessions. Colour: blue. Delivered with its carry bag. Can be installed on grass and on synthetic.

Reference: 064106

Pair = 4 Targets

TARGET FOR FOOTBALL GOAL



3 dimensions +



| Target    |
|-----------|
| L. 100 cm |
| H. 60 cm  |

| Goal 5x2m |
|-----------|
| L. 500 cm |
| H. 200 cm |

| Goal for 8 |
|------------|
| L. 600 cm  |
| H. 210 cm  |

| Goal for 11 |
|-------------|
| L. 732 cm   |
| H. 244 cm   |



Fixing by elastic straps



With recovery net

8 or 11-a-side nylon football target goal for precision work. It has 5 numbered targets (dimensions: 1 x 0.6m) with a net behind each target to make the ball recovery easier. Fixing by elastic straps.

Reference: 064122

Target for goal 5x2m - 22 straps provided

Reference: 064110

Target for goal for 8 - 26 straps provided

Reference: 064107

Target for goal for 11 - 30 straps provided

TARGET WITH WEIGHTED BASE



Available in 2 sizes

FOOTBALL for 8

FOOTBALL for 11



Supplied with a carrying bag



600 deniers polyester net. Ballast included to keep the net straight and taut. Quick fixing on the crossbar and posts due to its hook and loop fasteners.

Reference: 064022

For goal FOOTBALL for 8

Reference: 064023

For goal FOOTBALL for 11

TARGET WITH WEIGHTED BASE FOR HANDBALL/FUTSAL GOAL



weighted base



Supplied with a carrying bag

600 deniers polyester net. Ballast included to keep the net straight and taut. Quick fixing on the crossbar and the posts due to its hook and loop straps.

Reference: 064014

For HANDBALL goal



**BALL TENNIS / FUTNET / MINI-TENNIS KIT**

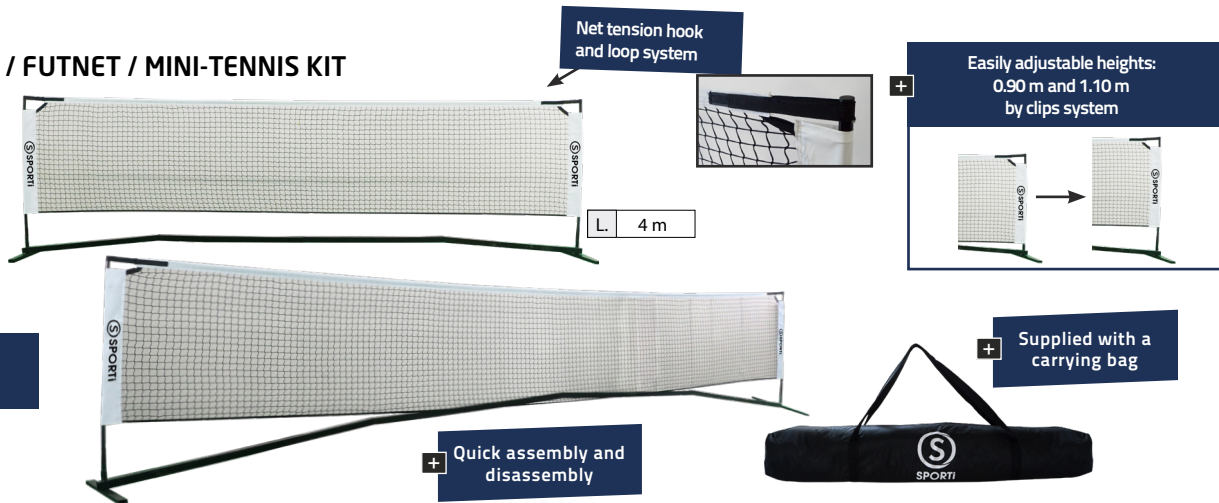

Set for both ball-tennis and mini-tennis. Steel rectangular structure very stable due to the wideness of its feet which avoid a lateral tip over as well as a back and forth tip over. Designed to use it on hard floor, grass and synthetic pitch. Very practical and easy to set up, this kit can be assembled and disassembled very quickly. Delivered with a net PE 2 mm, mesh 40 mm. Easy to carry due to its bag. Available in 2 lengths: 4 m and 6 m. 2 easily adjustable heights: 0.90 m and 1.10 m.

|                    |                                            |                    |         |
|--------------------|--------------------------------------------|--------------------|---------|
| Reference: 099046  | 4 m                                        | Reference: 099047  | 6 m     |
| Reference: 099046F | 4 m net                                    | Reference: 099047F | 6 m net |
| Reference: 0990475 | Carrying bag alone (compatible 4 and 6 m.) |                    |         |

**FUTNET KIT 4 M / 6 M**



|                                     |                                     |
|-------------------------------------|-------------------------------------|
| <b>FUTNET kit 4 M - Ref: 099042</b> | <b>FUTNET kit 6 M - Ref: 099043</b> |
| -FUTNET net 4 m (099046)            | -FUTNET net 6 m (099047)            |
| -Land marking kit (099045)          | -Land marking kit (099045)          |

Reference: 099045 Land marking kit (roll + 15 stakes)  
 Reference: 099044 Kit of 15 stakes

**INFLATABLE DUMMIES**



Automatically straightened up



This dummy will allow you to work on the «aerial game» of your goalkeepers in complete safety. Once the base is filled with water or sand and the top is inflated, this spike-resistant dummy will remain stable and secure.

|                   |        |
|-------------------|--------|
| Reference: 063476 | 180 cm |
| Reference: 063477 | 205 cm |

**• INFLATABLE DUMMY**



Automatically straightened up

|            |            |
|------------|------------|
| Empty tank | W. 2.15 Kg |
| Full tank  | W. 15 Kg   |

HEIGHT 185 cm

PVC inflatable training dummy, flexible and robust with carry handles. Perfect to work game situations in handball, football without injure yourself.

|                   |      |
|-------------------|------|
| Reference: 063435 | Unit |
|-------------------|------|



**DUMMY 180CM**

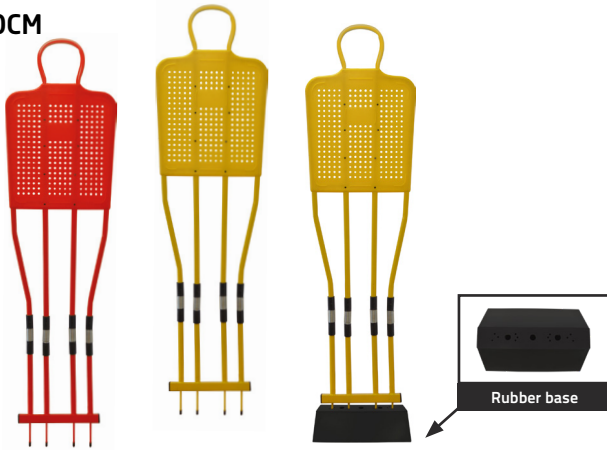

**JUNIOR DUMMY 106CM**

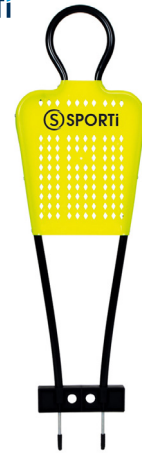

WIDTH  
33 cm

It is composed of a metal structure equipped of springs allowing it to fold without break and of a plastic breastplate. It can be fixed to the ground thanks to 4 metal points. It can be used on synthetic pitch thanks to its rubber base (not provided, ref 063454).

**SINGLE DUMMY**  
 Reference: 063452 Single yellow dummy  
 Reference: 063475 Single red dummy

**KIT OF 3 DUMMIES**  
 Reference: 063471 Set of 3 yellow dummies  
 Reference: 063483 Set of 3 red dummies

**DUMMY + BASE**  
 Reference: 063455 Yellow dummy + base  
 Reference: 063484 Red dummy + base

With its structure and its resistant and flexible plastic breastplate, this dummy will allow you to practice dribbling and free kicks with the youngest. With 2 steel spikes for planting in the ground (not compatible with bases 063454 and 063344).

Reference: 063481 Unit

**DUMMIES TROLLEY (WITHOUT DUMMY)**

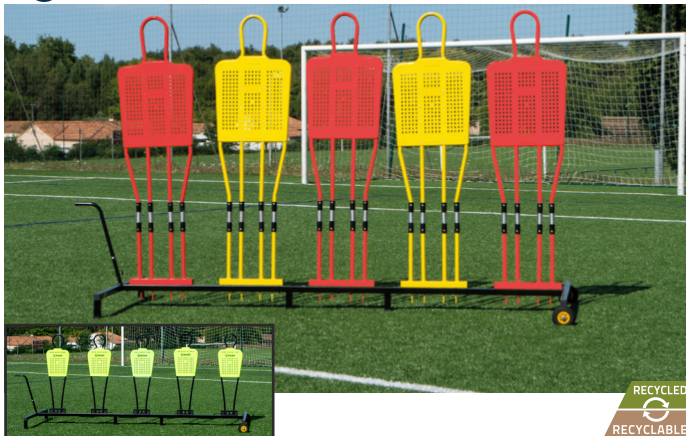

Dummies trolley, which can take the dummies ref 062717A, 063452 and 063475. Easy to assemble, very robust and manoeuvrable it will make your free kick sessions easier.

Reference: 062715 Unit

**DUMMY FOOTBALL PRO 180CM**

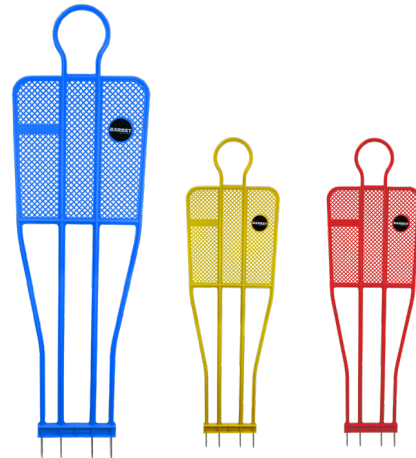

BARRET patent (official supplier of a lot of professional clubs). Very flexible, it folds up but never breaks. 4 steel points for a greater stability. Available in red, yellow and blue.

Reference: 062717A 180 cm

**FLEXIBLE DUMMY**



Flexible dummy delivered in its carrying bag. Sold as a kit with flexible slalom poles for grass ground or sand or with poles + bases for synthetic and hard grounds.

Reference: 063479 Set of 3 dummies + flexible slalom poles + carrying bag  
 Reference: 063478 Single flexible dummy

**WEIGHTED RUBBER BASE FOR DUMMIES**



Weighted rubber base. It allows to hold dummies in place on smooth or synthetic surfaces. Compatible with many dummies models. Weight : 12kg.

Reference: 063454 Single base

**TWO-IN-ONE WEIGHTED BASE FOR GOALS AND DUMMIES**



Claws on one base side allowing to weight mini goals and thus avoid their toppling. It is compatible with all mini goals with tube diameter until 40mm.

Reference: 063344 Unit

TCHOUKBALL

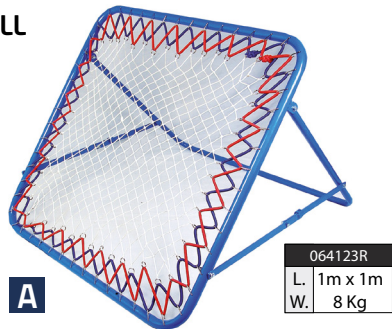

|         |         |
|---------|---------|
| 064123R |         |
| L.      | 1m x 1m |
| W.      | 8 Kg    |



|        |         |
|--------|---------|
| 064226 |         |
| L.     | 1m x 1m |
| W.     | 6.6 Kg  |



**A** Frame of 32 mm in blue painted steel with a nylon net fixed by straps. Adapted to the practice from a very early age and learning at initial rebounds.  
**B** Light frame of 40 mm in light steel, black colour. Adjustable inclination allowing to learn initial rebounds on all angles.

Reference: 064123R  
 Reference: 064123F  
 Reference: 064226

**A**  
**A** Spare net  
**B**



DOUBLE TCHOUKBALL

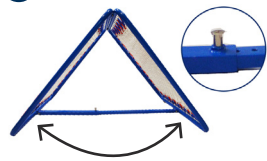

|       |     |
|-------|-----|
| Frame |     |
| L.    | 1 m |
| w.    | 1 m |

Adjustable from 50 to 70°

|            |  |
|------------|--|
| RECYCLABLE |  |
| WEIGHT     |  |
| 11.3 kg    |  |

Double Tchoukball with adjustable bar allowing to modify inclination (18 positions) and thus vary exercises (short game and long game). Perfect for technical and precision work, especially for goalkeepers and from a very early age. Blue steel frame of 32 mm with net fixed by 2 straps on removable hooks.

Reference: 064125 Unit

TCHOUKBALL 4 SIDES



|                 |       |
|-----------------|-------|
| Face dimensions |       |
| 90 cm           | 73 cm |
| 180 cm          |       |

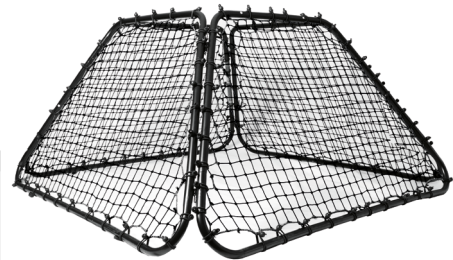

Tchoukball 4 sides allows to work some people at the same time. You can use it for team sports and individual sports... Perfect for technical work, physical, repeated and precision in particular for goalkeepers, from the youngest age. Easy to set up and to store. Black steel frame of 32 mm with polyethylene net and fixed by straps.

Reference: 064121 Unit

MINI TCHOUKBALL 76CM

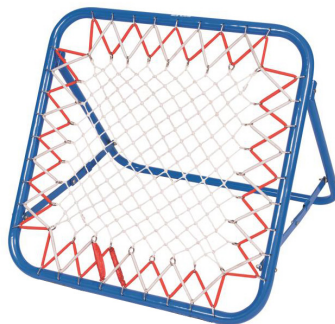

|       |       |
|-------|-------|
| Frame |       |
| L.    | 76 cm |
| w.    | 76 cm |

|            |  |
|------------|--|
| RECYCLABLE |  |
| WEIGHT     |  |
| 7 kg       |  |

32mm section frame, blue painted steel with a nylon net fixed by elastic straps. Adapted to practice from an early age and first rebounds learning.

Reference: 064045 Unit

HAND TCHOUKBALL



|       |       |
|-------|-------|
| Frame |       |
| L.    | 60 cm |
| w.    | 60 cm |

|        |  |
|--------|--|
| WEIGHT |  |
| 2 kg   |  |

Hand Tchoukball with rebound net to work reflexes especially during goalkeepers' training. Black steel frame of 25 mm with handles, dimensions 60 x 60 cm. Net fixed with strap on removable hooks.

Reference: 064124 Unit

PASSING ARC FOR SYNTHETIC FLOOR AND INDOOR USE



|       |         |
|-------|---------|
| Arc   |         |
| H.    | 40 cm   |
| L.    | 55 cm   |
| Bases |         |
| Ø     | 22 cm   |
| W.    | 1.25 Kg |



PVC high-quality passing arc for synthetic grounds and sand. Composed of one arc and two solid rubber bases.

Reference: 063323 Kit  
 Reference: 063322 Precision arch (Unit)

PASSING ARC

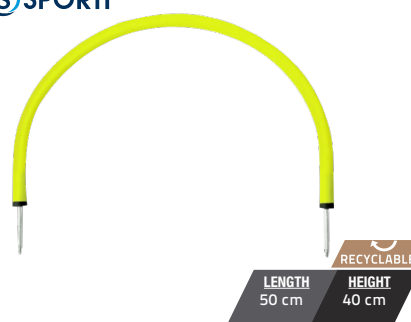

|            |  |
|------------|--|
| RECYCLABLE |  |
| LENGTH     |  |
| 50 cm      |  |
| HEIGHT     |  |
| 40 cm      |  |

High-quality passing arc with steel spikes.

Reference: 063247 Unit

FIXING STRIPS WITH HOOK AND LOOP FASTENER



It allows to fix a hoop on a handball or football goal in order to develop the precision.

Reference: 062719 Pair



TRAINING BIB



CUSTOMISABLE PRODUCT\*  
FROM 300 PIECES (on quotation)\*



| XXS Size |       |
|----------|-------|
| H.       | 48 cm |
| w.       | 40 cm |

| XS size |       |
|---------|-------|
| H.      | 56 cm |
| w.      | 48 cm |

| M size |       |
|--------|-------|
| H.     | 66 cm |
| w.     | 55 cm |

| XL size |       |
|---------|-------|
| H.      | 76 cm |
| w.      | 60 cm |

| 2XL/3XL size |       |
|--------------|-------|
| H.           | 90 cm |
| w.           | 65 cm |

Stretch fabric, soft touch, one of the best-valuable training bib of the market. 100% polyester. Available in 10 colours.

Reference: 063209      XXS to XL sizes - Unit

Reference: 063199      2XL/3XL size - only in Neon Yellow, Neon Orange, Red, Royal and Neon Green - Unit

2026 NEW      New size : 2XL/3XL



REVERSIBLE TRAINING BIB



CUSTOMISABLE PRODUCT\*  
FROM 300 PIECES (on quotation)\*



| XXS Size |       |
|----------|-------|
| H.       | 48 cm |
| w.       | 40 cm |

| XS Size |       |
|---------|-------|
| H.      | 56 cm |
| w.      | 48 cm |

| M Size |       |
|--------|-------|
| H.     | 66 cm |
| w.     | 55 cm |

| XL Size |       |
|---------|-------|
| H.      | 76 cm |
| w.      | 60 cm |

Reversible training bib with openwork stitches to increase breathability. 100 % polyester.

Reference: 063250      Unit

SET OF REVERSIBLE NUMBERED TRAINING BIBS



Reversible



| XS Size |       |
|---------|-------|
| H.      | 56 cm |
| w.      | 48 cm |

| M Size |       |
|--------|-------|
| H.     | 66 cm |
| w.     | 55 cm |

| XL Size |       |
|---------|-------|
| H.      | 76 cm |
| w.      | 60 cm |



PVC TRAINING BIBS HOLDER



Good flexibility



Very strong and durable flexible PVC ring for bibs transportation and storage. The top hook makes it easy to hang the bibs on stadium handrails. Training bib compartment diameter: 14.5 cm

Reference: 069209      Unit

SET OF NUMBERED TRAINING BIBS



| XS Size |       |
|---------|-------|
| H.      | 56 cm |
| w.      | 48 cm |

| M Size |       |
|--------|-------|
| H.     | 66 cm |
| w.     | 55 cm |

| XL Size |       |
|---------|-------|
| H.      | 76 cm |
| w.      | 60 cm |



Stretchy and pleasant to the touch, 100% polyester. Sold in a pack of 10 numbered from 1 to 10 or in a pack of 5 numbered from 11 to 15 or from 16 to 20. Heart and back numbers. Available in 3 sizes (XS, M and XL) and 4 colours (Blue, Yellow, Red and Green).

Reference: 063120      from 1 to 10 -set of 10      yellow, red, green and Blue

Reference: 063122      from 11 to 15 - set of 5      yellow, red, green and Blue

Reference: 063123      from 16 to 20 - set of 5      yellow, red, green and Blue

Reversible training bib with openwork stitches to increase breathability. 100% polyester.

Reference: 063237      from 1 to 10 -set of 10      Black/White or Red/Blue

Reference: 063238      from 11 to 15 - set of 5      Black/White or Red/Blue

Reference: 063236      from 16 to 20 - set of 5      Black/White or Red/Blue



SLALOM POLE WITH PLASTIC SPIKE 160 CM



SLALOM POLE 25MM



SLALOM POLE 32MM

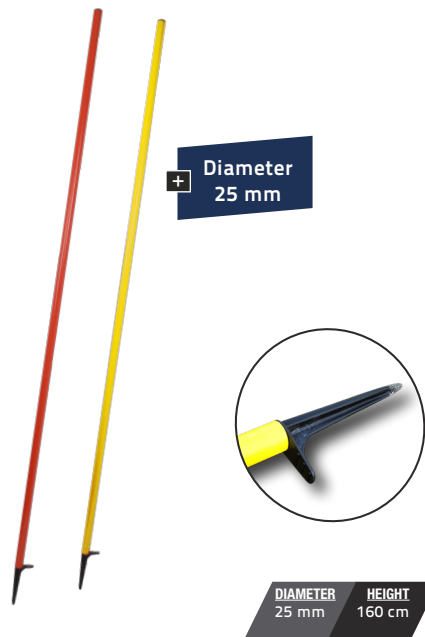

+ Diameter 25 mm

DIAMETER 25 mm  
HEIGHT 160 cm

Slalom pole with plastic spike. Available in yellow and red.

Reference: 063349 Unit

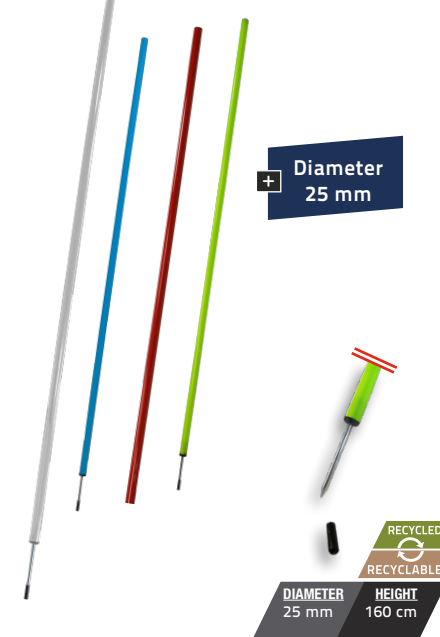

+ Diameter 25 mm

DIAMETER 25 mm  
HEIGHT 160 cm  
RECYCLED RECYCLABLE

PVC pole with steel spike. Available in yellow, blue, red and white.

Reference: 063130 Unit



+ Diameter 32 mm

DIAMETER 32 mm  
HEIGHT 170 cm  
RECYCLED RECYCLABLE

PVC pole with steel spike. Available in yellow, blue, red and white.

Reference: 063129 Unit

SLALOM POLE 160 CM FOR SYNTHETIC PITCH



+ Suitable for indoors

DIAMETER 25 mm  
HEIGHT 160 cm

This slalom pole is composed of a solid rubber base of 22 cm + pole. Available in yellow, blue or red.

Reference: 063312 Unit - Yellow

Reference: 063313 Unit - Blue

Reference: 063314 Unit - Red

FLEXIBLE SLALOM POLE



Single tip available individually

DIAMETER 25 mm

Flexible slalom pole to the base. Available in 3 colours and 4 sizes.

Reference: (Unit)

063319 80cm

063319 100cm

063319 120cm

063319 160cm

063427 Single tip

BAG FOR SLALOM POLES / POLES



+ Up to 50 slalom poles / poles

LENGTH 185 cm  
WIDTH 25 cm  
HEIGHT 25 cm

Reinforced nylon bag. Zip fastening. Due to its handles, this bag allows to easily transport up to 50 slalom poles.

Reference: 078063 Unit

KIT D «SLALOM POLES»



+ Offered bag

RECYCLED RECYCLABLE

- Set of 30 pcs of 160cm long slalom poles with steel spike, (15 red and 15 yellow)
- 1 nylon bag (FREE)

REFERENCE: 062997



STANDARD MARKER CONES



SET OF 20



SET OF 40



SET OF 60

+ Marker cone holder for free for 20 markers bought by the unit



Standard marker (unit)

|            |        |
|------------|--------|
| RECYCLABLE |        |
| DIAMETER   | HEIGHT |
| 19 cm      | 5.5 cm |

Supplied with marker cone holder for the transport and the storage (composed of 4 colours white, blue, orange and yellow).

|                    |                 |
|--------------------|-----------------|
| Reference: 063173  | Set of 20       |
| Reference: 063174  | Set of 40       |
| Reference: 063440  | Set of 60       |
| Reference: 063174U | Standard marker |

EXTRA-FLEXIBLE MARKER CONES WITHOUT NOTCH



+ Extra flexible



|          |        |
|----------|--------|
| DIAMETER | HEIGHT |
| 19.5 cm  | 3.5 cm |

EXTRA-FLEXIBLE MARKER CONES WITH NOTCHES



+ Extra flexible



|          |        |
|----------|--------|
| DIAMETER | HEIGHT |
| 19.5 cm  | 5 cm   |

Extra-flexible markers cones with notches allowing to fix poles at a height of 5cm to have mini hurdles. They fold up under the feet to avoid any risk of falling. Supplied with a support for the transport.

Extra-flexible marker cones, they fold up under the feet to avoid any risk of falling. Anti-UV treatment. Supplied with a holder for the transport.

|                   |           |                             |
|-------------------|-----------|-----------------------------|
| Reference: 063429 | Set of 20 | White                       |
| Reference: 063340 | Set of 20 | Blue/White/Orange/Yellow    |
| Reference: 063430 | Set of 40 | White                       |
| Reference: 063404 | Set of 40 | Blue/White/Orange/Yellow    |
| Reference: 063431 | Set of 20 | White                       |
| Reference: 063405 | Set of 20 | Yellow / Red                |
| Reference: 063407 | Set of 20 | Yellow / Red / White / Blue |
| Reference: 063432 | Set of 40 | White                       |
| Reference: 063406 | Set of 40 | Yellow / Red                |
| Reference: 063345 | Set of 40 | Yellow / Red / White / Blue |

MARKING DISCS



|            |  |
|------------|--|
| RECYCLABLE |  |
| DIAMETER   |  |
| 15.5 cm    |  |

Set of 24 marking discs non-skid, perfectly adapted to indoor trainings or on synthetic floor. Robust metal support designed to easily remove or put the discs back.

|                   |                                 |
|-------------------|---------------------------------|
| Reference: 063303 | Set (12 yellow and 12 orange)   |
| Reference: 063480 | Set (8 blue, 8 white and 8 red) |

WHITE MARKING DISCS



|            |  |
|------------|--|
| RECYCLABLE |  |
| DIAMETER   |  |
| 20.5 cm    |  |

Set of 20 white marking discs, non-skid, perfectly adapted to indoor trainings or on synthetic floor. Real asset for training as it does not deflect the ball. Robust metal support designed to easily remove or put the discs back.

|                   |           |
|-------------------|-----------|
| Reference: 063433 | Set of 20 |
|-------------------|-----------|

GROUND MARKERS WITH NUMBERS



|          |           |
|----------|-----------|
| DIAMETER | THICKNESS |
| 20.5 cm  | 3 mm      |

Ground markers with numbers from 1 to 10. Non-skid flexible rubber and robust with a grainy appearance on one side.

|                   |           |
|-------------------|-----------|
| Reference: 062981 | Set of 10 |
|-------------------|-----------|

LARGE MARKER CONES WITH NOTCHES



|            |        |
|------------|--------|
| RECYCLED   |        |
| RECYCLABLE |        |
| DIAMETER   | HEIGHT |
| 30 cm      | 16 cm  |

Delivered with a plastic support this set is composed of 12 markers cones of 3 different colours (red, yellow and blue). Markers cones with notches to fix mini hurdles with poles at different heights (5 - 10 - 15 cm).

|                   |           |
|-------------------|-----------|
| Reference: 062994 | Set of 12 |
|-------------------|-----------|

SET OF 20 EXTRA SOFT MARKING RINGS



+ Delivered with a mesh carry bag

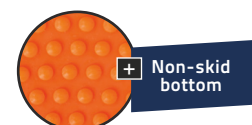

+ Non-skid bottom

|          |  |
|----------|--|
| DIAMETER |  |
| 19 cm    |  |

Set composed of 5 neon pink/ 5 turquoise/5 neon yellow/ 5 neon orange. Non-skid material, perfectly adapted to indoor trainings or on synthetic pitch. Its strengths are that they do not deflect the trajectory of the ball and that the hole in the middle allows to hold a ball in order to imagine any kind of game. Delivered in a mesh carry bag. 8 cm hole Ø.

|                   |           |
|-------------------|-----------|
| Reference: 063119 | Set of 20 |
|-------------------|-----------|



**SIMPLE SPEED LADDER 2 M**

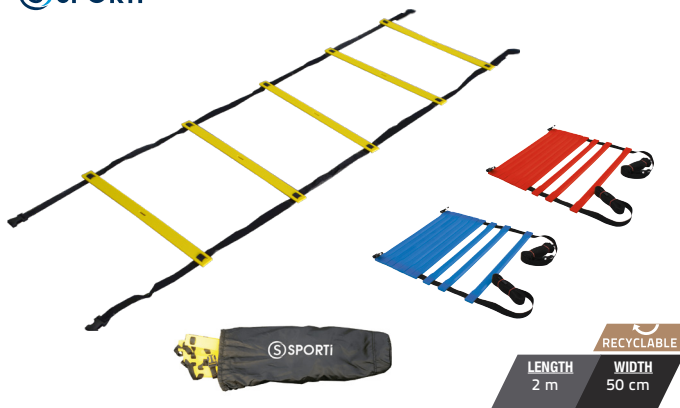

RECYCLABLE  
LENGTH 2 m WIDTH 50 cm

Made with 2 nylon straps and 5 flat bars for safety reasons, it is the perfect tool to work the coordination. Supplied with a carrying bag.

Reference: 063180A Unit - Yellow  
Reference: 063180A Unit - Blue  
Reference: 063180A Unit - Red

**SIMPLE SPEED LADDER 4 M**

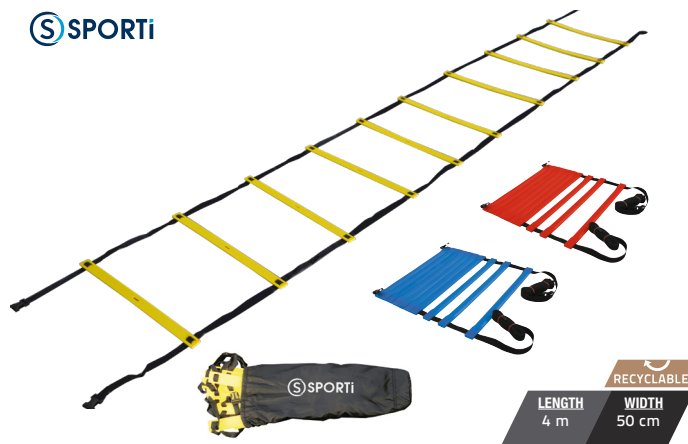

RECYCLABLE  
LENGTH 4 m WIDTH 50 cm

Made with 2 nylon straps and 10 flat bars for safety reasons, it is the perfect tool to work the coordination. Supplied with a carrying bag.

Reference: 063177A Unit - Yellow  
Reference: 063177A Unit - Blue  
Reference: 063177A Unit - Red

**DOUBLE SPEED LADDER**



RECYCLABLE  
LENGTH 4 m WIDTH 1 m

Same composition as the simple speed ladder, the double speed ladder allows to work in a different way in particular due to a longer distance between the bars. Supplied with a carrying bag.

Reference: 063178 Unit

**SET OF 12 OCTOGONAL HOOPS**



Delivered with a carrying bag

RECYCLABLE  
OUTSIDE Ø 49 cm

Set of 12 octagonal hoops with 10 joint clips. Colour: Neon yellow. Supplied with a carry bag. Outside Ø 49 cm.

Reference: 063456 Set

**SPEED LADDER FOR CROSS POSITIONING**

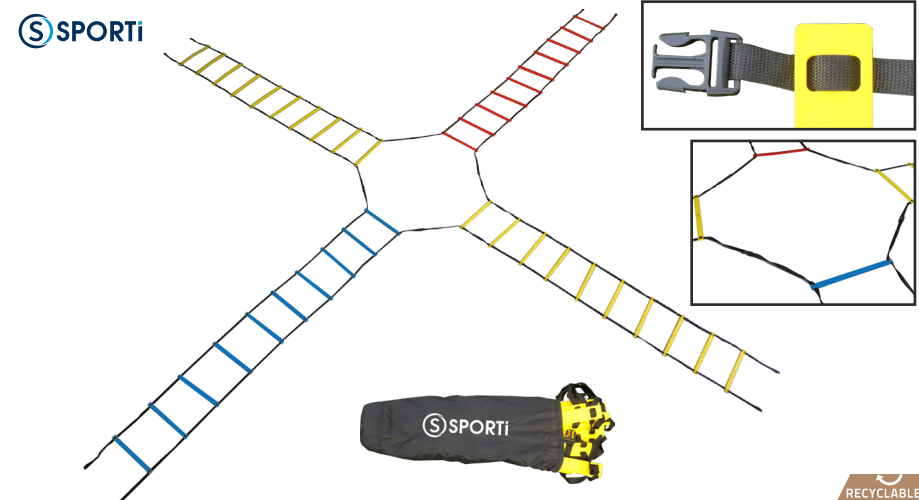

RECYCLABLE

Set of 4 simple speed ladders (2 Yellow, 1 Blue, 1 Red 063177A) allowing to form a «cross» (~ 10 x 10 m) in order to vary the motor activities. Supplied with a carrying bag. To assemble yourself.

Reference: 063451 Unit

**SET OF 10 TRAINING SLATS**



RECYCLED  
RECYCLABLE

LENGTH 50 cm WIDTH 4 cm HEIGHT 0.5 cm

Set of 10 slats in white PVC.

Reference: 025008



**FLEXIBLE HURDLE**

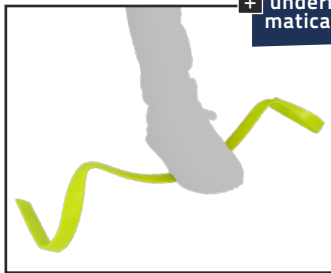

+ If it is pressed underfoot it will automatically straighten up

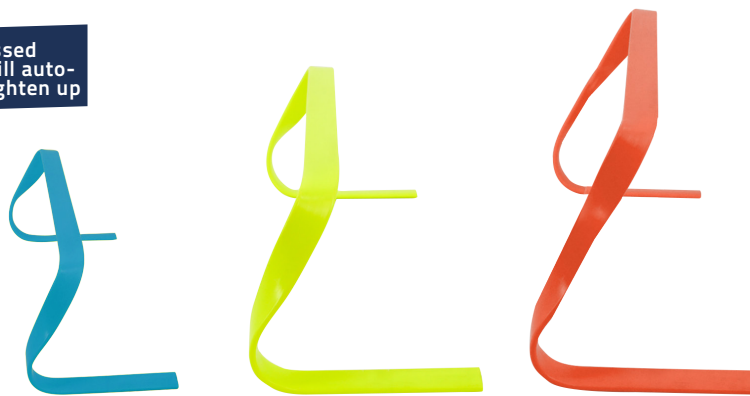

Flexible PVC hurdle to avoid any danger. It automatically gets its original position back if someone steps on.

|                   |             |             |           |
|-------------------|-------------|-------------|-----------|
| Reference: 063184 | Wid. 46 cm. | Hei. 15 cm. | Turquoise |
| Reference: 063185 | Wid. 46 cm. | Hei. 23 cm. | Yellow    |
| Reference: 063186 | Wid. 46 cm. | Hei. 30 cm. | Orange    |

**SPEED HURDLE**

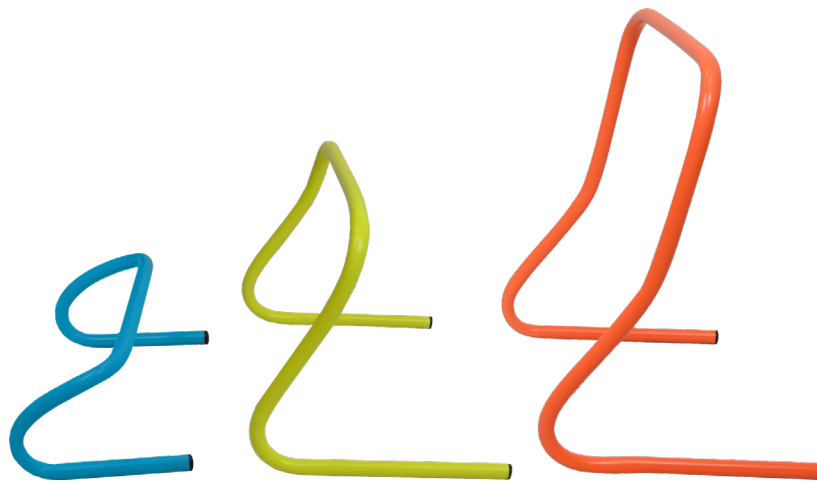

Hurdle in reinforced PVC. Practical and easy to transport and store.

|                    |             |             |           |
|--------------------|-------------|-------------|-----------|
| Reference: 063183A | Wid. 47 cm. | Hei. 15 cm. | Turquoise |
| Reference: 063183B | Wid. 47 cm. | Hei. 30 cm. | Yellow    |
| Reference: 063183C | Wid. 47 cm. | Hei. 45 cm. | Orange    |

**BOUNCE-BACK HURDLE**

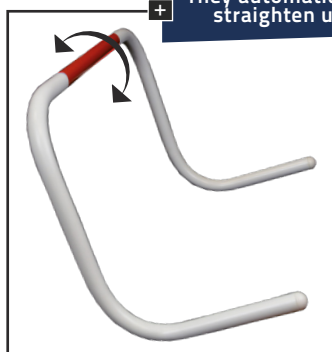

+ They automatically straighten up

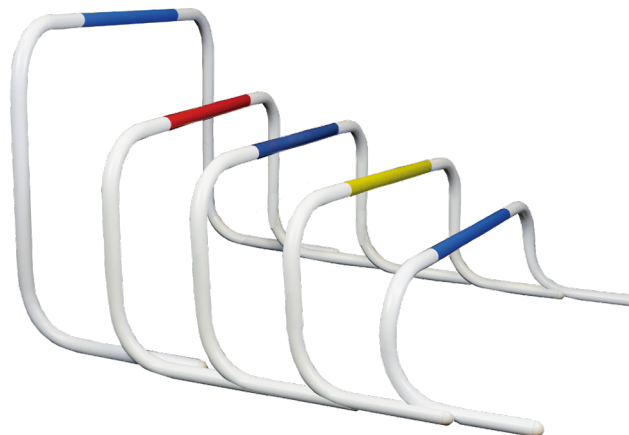

Very useful, these hurdles automatically straighten up.

|                    |            |             |              |
|--------------------|------------|-------------|--------------|
| Reference: 063302A | Wid. 70 cm | Hei. 21 cm. | White/Blue   |
| Reference: 063302B | Wid. 70 cm | Hei. 26 cm. | White/Yellow |
| Reference: 063302C | Wid. 70 cm | Hei. 31 cm. | White/Blue   |
| Reference: 063302D | Wid. 70 cm | Hei. 36 cm. | White/Red    |
| Reference: 063302E | Wid. 70 cm | Hei. 50 cm. | White/Blue   |



**SIMPLE CONE**



PVC standard cone with a square base for a greater stability. Available in 4 colours: Yellow / Red / Green / Blue.

Reference: 063332A 20 cm.  
Reference: 063332B 30 cm.

**EXTRA FLEXIBLE CONE**



**+ Unbreakable**

HEIGHT  
15 cm

Extra flexible cone with a round base, unbreakable, it folds up under the feet to avoid any risk of falling. Available in 6 different colours: Yellow / Red / Green / Orange / Purple / Blue.

Reference: 063013 15 cm.

**MULTI-ACTIVITIES 30-CM HIGH / 8 HOLES**



DIAMETER 25 cm  
HEIGHT 30 cm

PVC cone with holes (8 holes) with 2-level special base for greater flexibility. Can receive all the poles with a standard diameter, notch for flat hoop. Available in 4 different colours: Yellow / Red / Green / Blue.

Reference: 063333 Unit

**MULTI-ACTIVITIES 50-CM HIGH / 12 HOLES**



DIAMETER 30 cm  
HEIGHT 50 cm

PVC cone with holes (12 holes) with 2-level special base for greater flexibility. Can receive all the poles with a standard diameter, notch for flat hoop. Available in 4 different colours: Yellow / Red / Green / Blue.

Reference: 063334 Unit

**STANDARD CONES**



Polyethylene cone with square base. Available in 2 colours: Yellow / Red.

Reference: 063086 18 cm. Yellow / Red  
Reference: 063086C 23 cm. Yellow / Red  
Reference: 063086E 37 cm. Yellow / Red

**FLEXIBLE RUBBER CONE**



Polyethylene cone with wide round base, very stable. Available in 3 colours: Yellow / Red / Green.

Reference: 063330A 20 cm. 200 gr. Yellow / Red / Green  
Reference: 063330B 35 cm. 700 gr. Yellow / Red / Green



**KIT H «MULTI-JUMPS 30-CM HIGH» PER UNIT**



+ Matching colours

KIT



▪ 1 set of 2 30-cm high cones with 8 holes + 1 pole of 1 m. REF: 063324

**KIT B «MULTI-JUMPS KIT 30-CM HIGH» PER 5**



+ Matching colours

KIT



▪ 1 set of 10 30-cm high cones with 8 holes + 5 poles of 1 m. REF: 062998

**KIT I «MULTI-JUMPS 50-CM HIGH» PER UNIT**



+ Matching colours

KIT



▪ 1 set of 2 50-cm high cones with 12 holes + 1 pole of 1 m. REF: 063325

**KIT C «MULTI-JUMPS KIT 50-CM HIGH» PER 5**

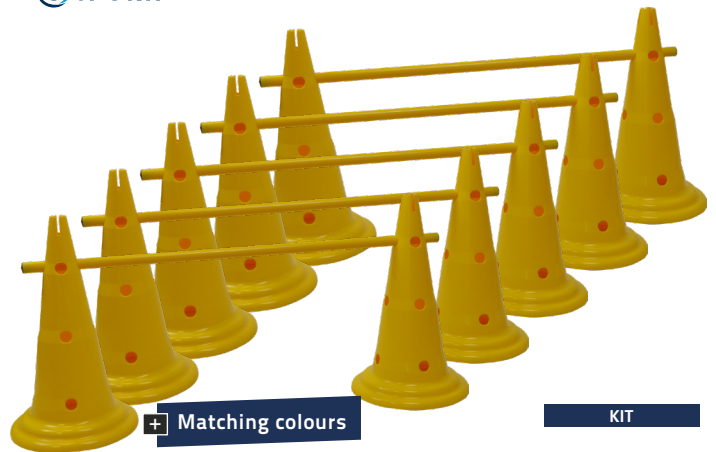

+ Matching colours

KIT



▪ 1 set of 10 50-cm high cones with 12 holes + 5 poles of 1 m. REF: 063274

**SPEED HURDLES KIT**



KIT



This kit contains: 4 speed hurdles of 15 cm, 4 speed hurdles of 30 cm, 4 speed hurdles of 45 cm and one hurdles carrier.

Reference: 063308

Kit

Reference: 063304

Single hurdle carrier

FLAT HOOP

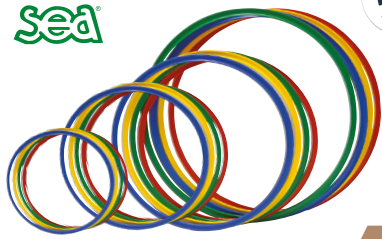

RECYCLABLE

Flat hoops allowing a greater stability to use on the floor. Available in 4 colours: red, green, yellow and blue.

|                    |      |        |
|--------------------|------|--------|
| Reference: 063027H | Unit | Ø40cm. |
| Reference: 063027E | Unit | Ø50cm. |
| Reference: 063027F | Unit | Ø60cm. |
| Reference: 063027J | Unit | Ø70cm. |

FLAT-HOOP KIT



- 10 flat hoops of 40 cm in diameter
- 10 flat hoops of 50 cm in diameter
- 10 flat hoops of 60 cm in diameter
- 1 hoop carrier

|                   |                   |
|-------------------|-------------------|
| Reference: 063309 | Kit               |
| Reference: 063304 | Hoop carrier only |

SET OF 12 EXTRA-FLAT HOOPS

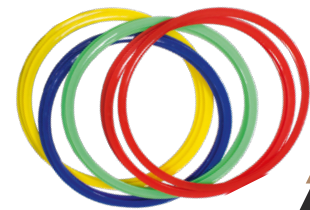

RECYCLABLE  
DIAMETER  
45 cm

Extra flat and extra flexible hoops. They fold up as much as you want without losing their original shape. 3 hoops of each colour (blue, green, yellow and red).

|                   |           |
|-------------------|-----------|
| Reference: 063026 | Set of 12 |
|-------------------|-----------|

ROUND HOOP

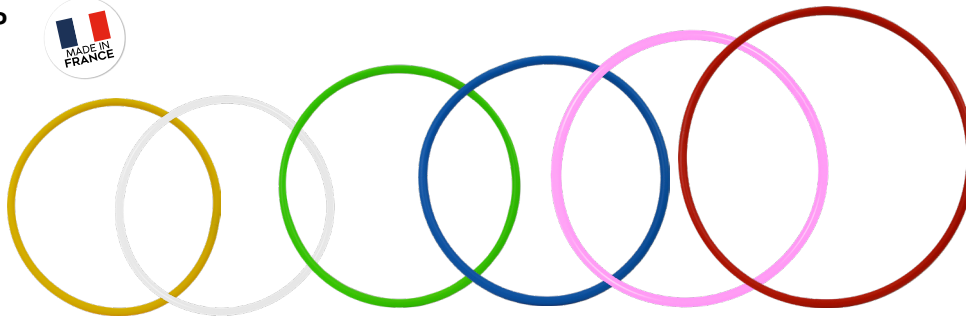

RECYCLED  
RECYCLABLE

Available in 6 colours (white, red, green, yellow, pink and blue).

|                    |      |        |
|--------------------|------|--------|
| Reference: 063028  | Unit | Ø50cm. |
| Reference: 063028A | Unit | Ø65cm. |
| Reference: 063028C | Unit | Ø75cm. |
| Reference: 063028D | Unit | Ø85cm. |

PLASTIC POLE WITH CAPS

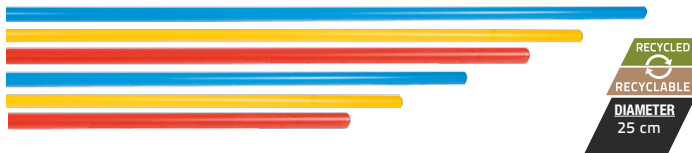

RECYCLED  
RECYCLABLE  
DIAMETER  
25 cm

Plastic pole with black caps at each end. Available in 3 different colours: Yellow / Red / Blue.

|                    |            |
|--------------------|------------|
| Reference: 063022H | L : 80cm.  |
| Reference: 063022M | L : 100cm. |
| Reference: 063022J | L : 120cm. |
| Reference: 063022C | L : 140cm. |
| Reference: 063022K | L : 160cm. |
| Reference: 063022D | L : 180cm. |

RIGID BASE IN PVC



RECYCLED  
RECYCLABLE  
WEIGHT  
220 g  
HEIGHT  
11 cm

PVC fillable rigid base. Yellow. For poles: 25 mm Ø.

|                   |
|-------------------|
| Reference: 063396 |
|-------------------|

MULTI FUNCTION BASE

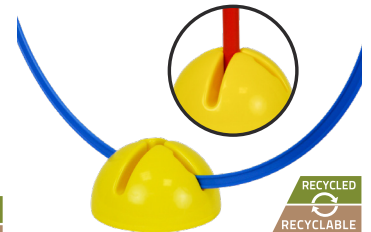

RECYCLED  
RECYCLABLE  
WEIGHT  
350 g  
HEIGHT  
11 cm

Multi-function base for 25 mm-diam poles, as well as flat or round hoops. Yellow.

|                   |
|-------------------|
| Reference: 063170 |
|-------------------|

FLEXIBLE BASE IN PVC



DIAMETER  
24 cm  
WEIGHT  
850 g  
HEIGHT  
12 cm

Flexible base in PVC. For pole of 25 mm Ø.

|                   |
|-------------------|
| Reference: 063075 |
|-------------------|

RUBBER BASE



RECYCLABLE  
DIAMETER  
22 cm  
WEIGHT  
1.25 kg

Solid rubber base. For poles: 25 mm Ø.

|                   |
|-------------------|
| Reference: 063172 |
|-------------------|

RUBBER BASE 3 HOLES



RECYCLABLE  
DIAMETER  
23 cm  
WEIGHT  
1.25 kg

3-holes rubber base to fix a max of 3 poles or to build V-shaped slalom obstacles or courses. Suitable for poles 25mm diam.

|                   |
|-------------------|
| Reference: 063346 |
|-------------------|



**TRAINING KIT WITH FILLABLE BASES**



Contains 2 fillable bases, 3 poles of 1.60m length. 2 attachment clips allowing to unite the kit.

Reference: 062723 Unit

**TRAINING KIT WEIGHTED**



This kit contains: 2 black weighted flat bases, 3 poles of 1.60 m length. 2 attachment clips allowing to unite the kit.

Reference: 062722 Unit

**CLIPS**



Rotating multi-use clip allows to hold tubes and hoops between them (example: show jumping, used with the hoops to create targets, etc.).  
A/ Set of 12 in 4 colours: Yellow / Red / Green / Blue.

Ref: 064424 Rotating multi-use clips  
Ref: 063131 Black multi-use clips  
A Set of 12  
B Unit

**KIT A «THE MUST-HAVES»**

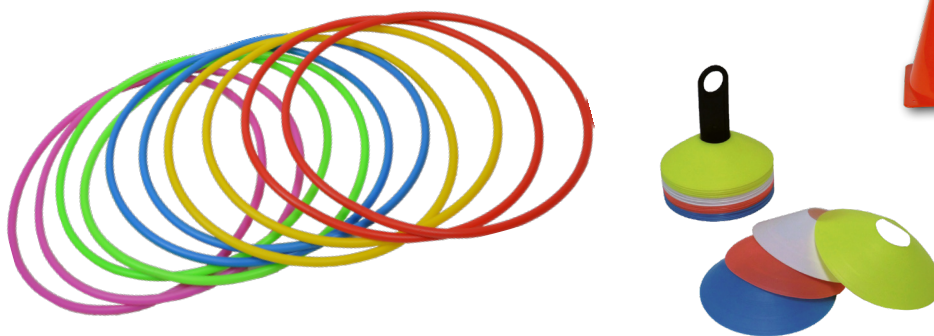

▪ 1 set of 40 markers cones ▪ 1 set of 10 pcs of 65cm diameter round hoops ▪ 1 set of 10 pcs of 23 cm high standard cones REFERENCE: 062999

**KIT E «COMPLETE KIT»**

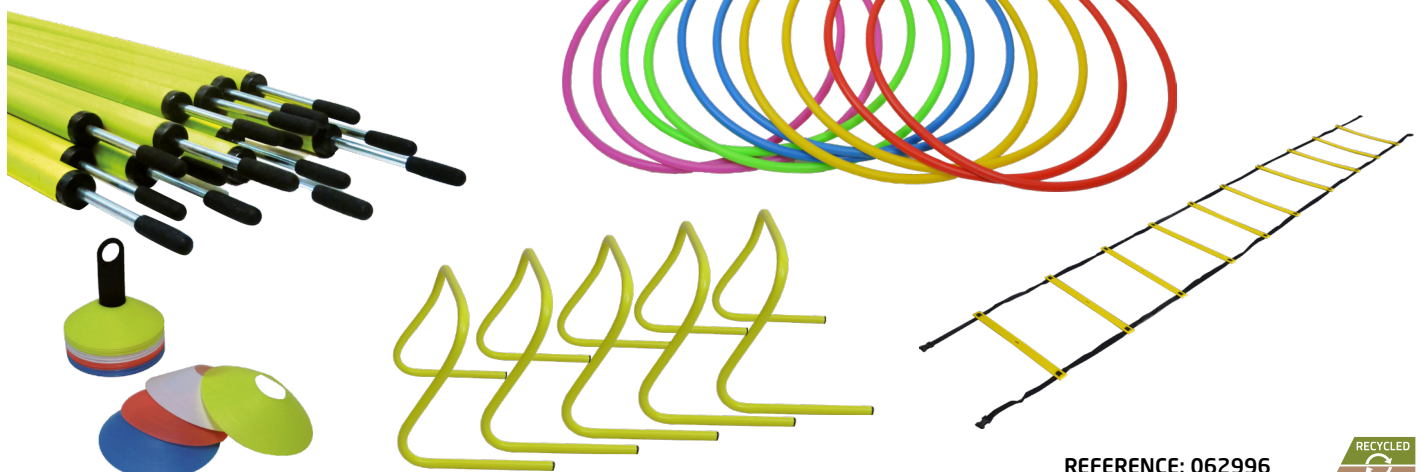

REFERENCE: 062996

▪ 1 set of 40 markers cones ▪ 1 set of 10 pcs of 65cm diameter round hoops ▪ 1 set of 12 slalom poles with steel spike  
▪ 1 simple 4-m speed ladder ▪ 1 set of 5pcs of 30cm high speed hurdles



**POWER SPEED**

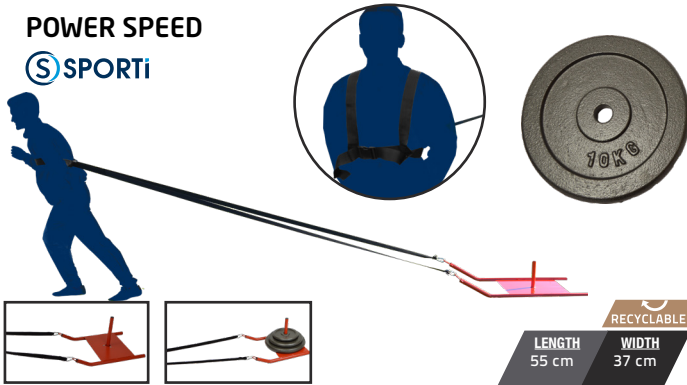

RECYCLABLE  
LENGTH 55 cm  
WIDTH 37 cm

Power Speed is recommended for resistance exercises in order to develop explosivity and running speed. It is also highly effective to improve the starting speed. Adapted for all sizes thanks to its adjustable belt, this tool is playful and user-friendly. Initial weight: 3.5 kg. Possibility to add some weights until 60 kg.

|                    |                       |
|--------------------|-----------------------|
| Reference: 060063  | Unit                  |
| Reference: 060063S | Single strap          |
| Reference: 062758  | Training weight 5kg.  |
| Reference: 062759  | Training weight 10kg. |
| Reference: 062760  | Training weight 20kg. |

**• CAST-IRON WEIGHT DISC**



RECYCLABLE

Cast-iron weight disc adapted to strength training bars of 28 mm diameter.

|                   |        |
|-------------------|--------|
| Reference: 062758 | 5 kg.  |
| Reference: 062759 | 10 kg. |
| Reference: 062760 | 20 kg. |

**TRAINING HARNESS**

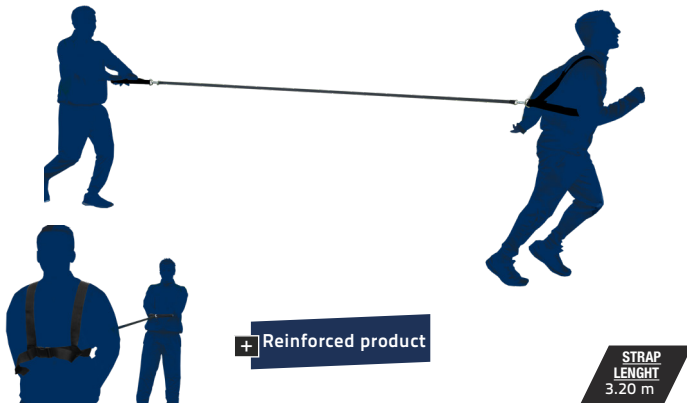

+ Reinforced product

STRAP LENGTH 3.20 m

This training harness is perfect to work the muscle-strengthening. Widely used in sports that require accelerations and sprints of short distances. It has a foam handle very ergonomic for the person who exerts a force against the sportsman movement, a harness very comfortable held to the shoulder level to avoid any risk of injury.

|                   |      |
|-------------------|------|
| Reference: 062735 | Unit |
|-------------------|------|

**PARACHUTE**

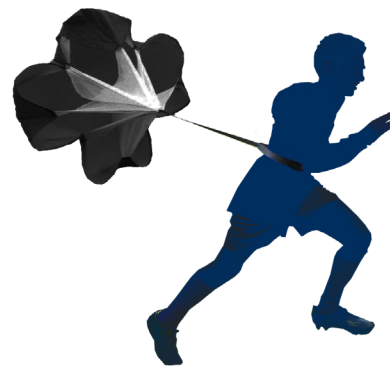

Training parachute in durable nylon with belt. It allows to work speed and power.

|                   |      |
|-------------------|------|
| Reference: 060077 | Unit |
|-------------------|------|

**FLAT BANDS / SET OF 4 ELASTIC FLAT BANDS**



LENGTH 50 cm  
WIDTH 5 cm

Set of 4 different tension bands delivered in your carry bag and used for muscle-strengthening, Pilates, rehabilitation or during training. Their length of 50 cm (25 cm flat) and their width of 5 cm, bring them a maximum comfort, especially at thighs and ankles level. Colours: yellow, red, blue and green.

|                   |     |
|-------------------|-----|
| Reference: 044030 | Set |
|-------------------|-----|

**POWER BAND / RESISTANCE ELASTIC BAND**



RECYCLED  
RECYCLABLE

LENGTH 1.04 m  
THICKNESS 4.5 mm

Resistance band with closed loop. Latex material allowing its elasticity, used for different exercises of muscle-strengthening.

|                   |                       |           |       |
|-------------------|-----------------------|-----------|-------|
| Reference: 044058 | Small strength        | 1.3 cm w. | Blue  |
| Reference: 044059 | Medium strength       | 1.9 cm w. | Grey  |
| Reference: 044060 | Strong strength       | 2.2 cm w. | Black |
| Reference: 044061 | Extra strong strength | 2.9 cm w. | Red   |



**FLEXIBLE AND INFLATABLE MEDICINE BALL**



Flexible and inflatable medicine ball, perfect for bodybuilding and training exercises. Flexible and enjoyable material for a greater grip.

|                   |               |         |
|-------------------|---------------|---------|
| Reference: 044025 | 1kg. / yellow | Ø 23cm. |
| Reference: 044026 | 2kg. / green  | Ø 23cm. |
| Reference: 044027 | 3kg. / Blue   | Ø 23cm. |
| Reference: 044028 | 4kg. / red    | Ø 23cm. |
| Reference: 044029 | 5kg. / purple | Ø 23cm. |

**INFLATABLE MEDICINE BALL**



Inflatable medicine ball. Great grip thanks to its rough rubber coating. It will allow you to perform carefully all your bodybuilding and training exercises.

|                   |                |           |
|-------------------|----------------|-----------|
| Reference: 021021 | 1 kg. / yellow | Ø 18cm.   |
| Reference: 021022 | 2 kg. / green  | Ø 19cm.   |
| Reference: 021023 | 3 kg. / red    | Ø 22.6cm. |
| Reference: 021024 | 4 kg. / Blue   | Ø 22.6cm. |
| Reference: 021025 | 5 kg. / orange | Ø 23cm.   |

**DOUBLE-HANDED MEDICINE BALL**



PVC medicine ball with 2 handles allowing to change hands and thus exercises. Soft and nice touch.

|                   |               |         |
|-------------------|---------------|---------|
| Reference: 021017 | 4kg. / yellow | Ø 25cm. |
| Reference: 021018 | 6kg. / green  | Ø 25cm. |
| Reference: 021019 | 8kg. / red    | Ø 25cm. |
| Reference: 021020 | 10kg. / Blue  | Ø 25cm. |

**KETTLEBELL**



Vinyl kettlebell.

|                   |       |        |
|-------------------|-------|--------|
| Reference: 044119 | 4kg.  | Pink   |
| Reference: 044120 | 8kg.  | Yellow |
| Reference: 044121 | 10kg. | Grey   |
| Reference: 044122 | 12kg. | Blue   |
| Reference: 044123 | 16kg. | Red    |
| Reference: 044124 | 20kg. | Black  |

**HEXAGONAL DUMBBELL**



Hexagonal PVC dumbbell with slip-resistant chrome-plated steel handle. Its hexagonal shape prevents from rolling on the floor. Sold individually.

|                   |         |
|-------------------|---------|
| Reference: 044136 | 6kg.    |
| Reference: 044137 | 8kg.    |
| Reference: 044138 | 10kg.   |
| Reference: 044139 | 12.5kg. |
| Reference: 044140 | 15kg.   |
| Reference: 044142 | 20 kg.  |

**WEIGHTED SAND BAG**



Delivered weighted +

Black vinyl coating bag with 3 reinforced straps of prehension and holding. Identifiable weight on each side of the bag. For physical preparation, the practice of Cross Training and Crossfit.

|                   |       |
|-------------------|-------|
| Reference: 044044 | 5 Kg  |
| Reference: 044045 | 10 Kg |
| Reference: 044046 | 15 Kg |
| Reference: 044047 | 20 Kg |
| Reference: 044048 | 25 Kg |

**WEIGHTED VEST**



Delivered with removable weights +

Tricking your body into working out with at a heavier weight lead to better conditioning and increased strength, speed and explosiveness. Add resistance to your workout with adding or removing the provided weights! Features fully adjustable hook and loop straps (10kg vest) or clips (5kg vest).

|                   |                               |
|-------------------|-------------------------------|
| Reference: 062767 | 5 kg vest (w. 36cm. H. 36cm.) |
| Reference: 062736 | 10 kg vest (w. 44cm. H.55cm.) |



BALANCE BALL TRAINER



Removable elastic

Delivered with a pump

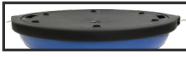

| WEIGHT | DIAMETER | HEIGHT |
|--------|----------|--------|
| 6 kg   | 63 cm    | 22 cm  |

Material allowing the work of balance, abdominals, gluteus and back muscles strengthening. It also allows to work your proprioception. Removable elastics included. Maximum weight: 150 kg.

Reference: 044078 Unit

PILATES AIR CUSHION



Non-skid underside



| DIAMETER | HEIGHT |
|----------|--------|
| 33 cm    | 7 cm   |

Ideal for improving balance and posture, proprioception and stimulation of foot soles. Maximum weight: 100 kg.

Reference: 044073 Unit

GYMBALL



Ideal for core strength and stability programs that target toning, stretching, back care, balance and rehabilitation. Durable, anti-burst construction (even in contact with a sharp object) - easy to use and easy to clean. Up to 300kg. Supplied with 2 air stoppers and 1 remover. Individual packing. Diameter +/- 10%.

|                   |                 |         |            |
|-------------------|-----------------|---------|------------|
| Reference: 044130 | 55cm.Ø          | 900 gr  | Light grey |
| Reference: 044131 | 65cm.Ø          | 1100 gr | Turquoise  |
| Reference: 044132 | 75cm.Ø          | 1300 gr | Dark grey  |
| Reference: 044114 | 1. Plug remover |         |            |

STEPPER 68X28CM - 2 HEIGHTS

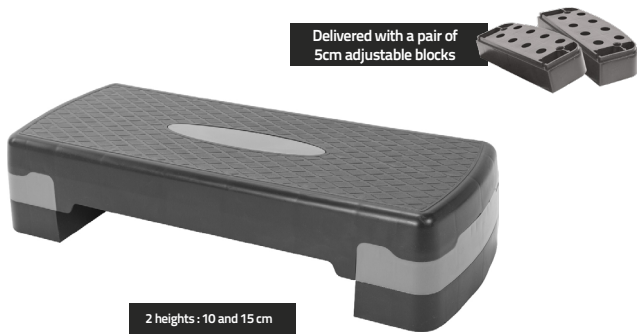

Delivered with a pair of 5cm adjustable blocks

2 heights: 10 and 15 cm

| LENGTH | WIDTH | HEIGHT |
|--------|-------|--------|
| 68 cm  | 28 cm | 15 cm  |

Non-slip stepper surface for a safer work. 2 additional riser blocks to change height from 10 to 15 cm. Both riser blocks can be stored under the stepper. Max weight: 120kg.

Reference: 044101 Stepper + adjustable risers

WOODEN PLYBOX/EVA 3 IN 1



| WEIGHT | DEPTH | WIDTH | HEIGHT |
|--------|-------|-------|--------|
| 27 kg  | 61 cm | 76 cm | 51 cm  |

Plyometric platform with 3 heights (51cm, 61cm and 76cm) allowing to work spring and explosivity. Its internal wooden structure provides stability and the foam covering EVA and anti-slip vinyl guarantee a safe work. Dimensions: 51x61x76cm. Weight: 27kg.

Reference: 044141 Unit

FOAM GYM MAT

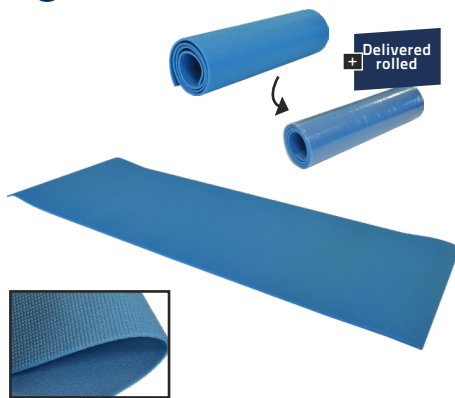

Delivered rolled

183CM MAT



Delivered rolled with an elastic carrier

| LENGTH | WIDTH | THICKNESS |
|--------|-------|-----------|
| 183 cm | 61 cm | 10 mm     |

With eyelets. Delivered rolled with a carriage elastic. Foam mat of high quality.

Reference: 043013 183 x 60 x 1cm - Black

Turquoise colour. Non-skid coating on 1 face.

Reference: 043018 Unit

FITNESS ROLL



| DIAMETER | WEIGHT | LENGTH |
|----------|--------|--------|
| 14 cm    | 630 g  | 33 cm  |

Massage roll in PE foam. Flexible relief structure allowing an optimal massage. Perfect to treat muscular aches and to improve blood circulation.

Reference: 044088 Unit

FLUO SKIPPING ROPES 2.75 M



Plastic fluo unicoloured. Available in 4 different colours: yellow, blue, green and red.

Reference: 044036B 2.75m.





|                         | SCO                | DT1                                | DT280                                           | DT480                                           |
|-------------------------|--------------------|------------------------------------|-------------------------------------------------|-------------------------------------------------|
| Rows                    | 1                  | 1                                  | 2                                               | 2                                               |
| Precision timer         | 1/100sec           | 1/100sec for 30 minutes, then 1/1. | 1/100sec - 8 memories                           | 1/100sec - 50 memories                          |
| Record time             | 24h                | 24h                                | 10h                                             | 10h                                             |
| Time / calendar / alarm | ✓/✓/✓              | ✓/✓/✓                              | -/-/-                                           | -/-/-                                           |
| Pace function           | -                  | -                                  | From 2 to 600/min                               | From 2 to 600/min                               |
| Countdown timer         | -                  | -                                  | Program mode<br>Time signal<br>Sequence counter | Program mode<br>Time signal<br>Sequence counter |
| Lap / split option      | -/✓                | -/✓                                | ✓/✓                                             | ✓/✓                                             |
| Water-resistance        | -                  | ✓                                  | ✓                                               | ✓                                               |
| Dimensions (mm)         | 83X62X23mm         | 68X60X15mm                         | 68X63X20mm                                      | 68X63X20mm                                      |
| Screen size (mm)        | 35X17mm            | ~28mm Ø                            | 38X22mm                                         | 38X22mm                                         |
| Digits                  | 6                  | 6                                  | 15                                              | 15                                              |
| Digits size (mm)        | 12                 | 8                                  | 7.5 / 5                                         | 7.5 / 5                                         |
| Weight                  | 44gr.              | 63gr.                              | 60gr.                                           | 60gr.                                           |
| Batteries               | LR44               | LR44                               | CR2032                                          | CR2032                                          |
| Blister pack            | ✓  RECYCLABLE      | ✓  RECYCLABLE                      | ✓  RECYCLABLE                                   | ✓  RECYCLABLE                                   |
|                         | Reference: 024017B | Reference: 024100                  | Reference: 024103                               | Reference: 024104                               |

30 MEMORIES STOPWATCH

SPORTI



Start tab



Back clip

Reference: 024063

Unit

60 MEMORIES STOPWATCH

SPORTI



Tongue insulator on the battery



Back clip

Reference: 024079

Unit

30 memories stopwatch with 1/100s precision and 10-hour recording capacity. Sound pacer from 10 to 320/min, programmable countdown timer, lap/split statistics, backlighting and splash-resistant design.

60 memories stopwatch with 1/100s precision and 10-hour recording capacity. Sound pacer from 10 to 320/min, programmable countdown timer, lap/split statistics, backlighting and splash-resistant design.

**ARMBAND**  
**SPORTi**

+ All our armbands are supplied in individual packaging easy to put on shelves



**WIDTH**  
9 cm      **LENGTH**  
35 cm

With elastic and large hook and loop to increase comfort.

|                   |                        |
|-------------------|------------------------|
| Reference: 063102 | SPORTS MANAGER ARMBAND |
| Reference: 063258 | DELEGATE               |
| Reference: 063259 | ORGANISATION           |
| Reference: 063260 | TRAINER                |
| Reference: 063261 | ASSISTANT              |
| Reference: 063262 | HEALER                 |
| Reference: 063263 | MEDICAL STAFF          |
| Reference: 063264 | SECURITY               |
| Reference: 063240 | PHYSICAL TRAINER       |

**MOURNING ARMBAND**



Reference: 063257      Unit

**WIDTH**  
5 cm

**PLAIN ARMBAND**

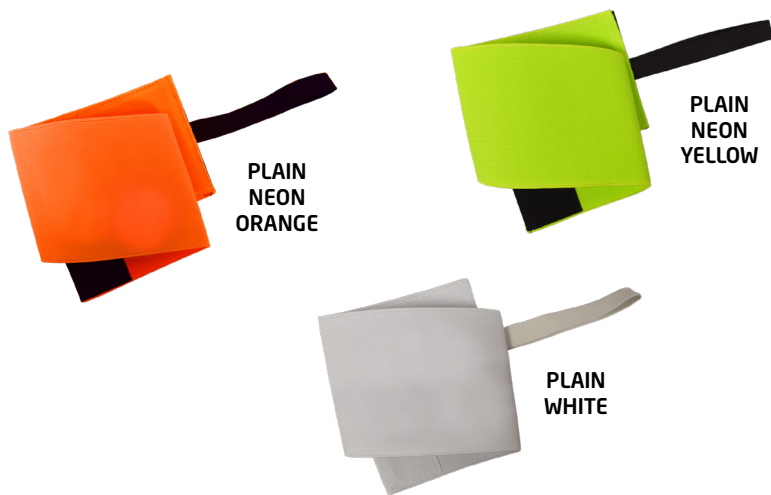

**WIDTH**  
9 cm      **LENGTH**  
35 cm

With elastic and large hook and loop fastener to increase comfort.

|                   |             |
|-------------------|-------------|
| Reference: 063266 | White       |
| Reference: 063266 | Neon orange |
| Reference: 063266 | Neon yellow |



«C» ARMBAND

SPORTi



NEON YELLOW



NEON ORANGE

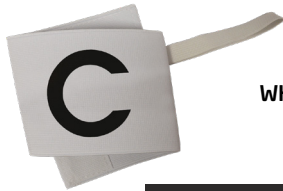

WHITE



NAVY

4 colours available : Neon yellow, Neon orange, White and Navy.



+ All our armbands are supplied in individual packaging easy to put on shelves



WIDTH 9 cm LENGTH 35 cm

With elastic and large hook and loop to increase comfort.

Reference: 063255

Unit

REVERSIBLE ARMBAND

SPORTi

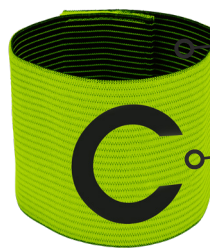

BLACK

NEON YELLOW

+ 1 armband = 2 possibilities!



WIDTH 9 cm LENGTH 35 cm

Reversible armband. With large hook and loop to increase comfort.

Reference: 063225

Unit

CLASSIC CAPTAIN ARMBAND

SPORTi

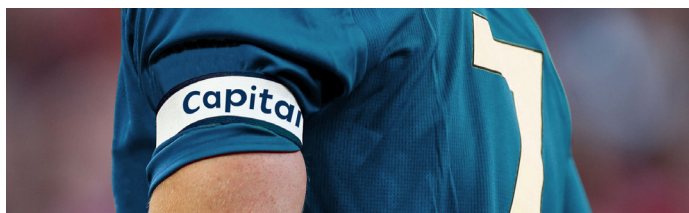

WIDTH 4 cm

With elastic and large hook and loop to increase comfort.

Reference: 063224

Unit

ELASTIC CAPTAIN ARMBAND

SPORTi



WIDTH 8 cm

2 colours available (Red / White and Blue / White).

Reference: 063254J

Junior

Reference: 063254S

Senior

PLAIN LINESMAN FLAG



PVC handle with a flag delivered with a carrying bag. Sold per pair.

Reference: 063126 Pair

CHEQUERED LINESMAN FLAG



PVC handle with a flag delivered with a carrying bag. Sold per pair.

Reference: 063095 Pair

MULTI-CHEQUERED LINESMAN FLAG



PVC handle with a flag delivered with a carrying bag. Sold per pair.

Reference: 063095A Pair

• ELECTRONIC LINESMAN FLAG KIT



Reliable system and proven for over 25 years

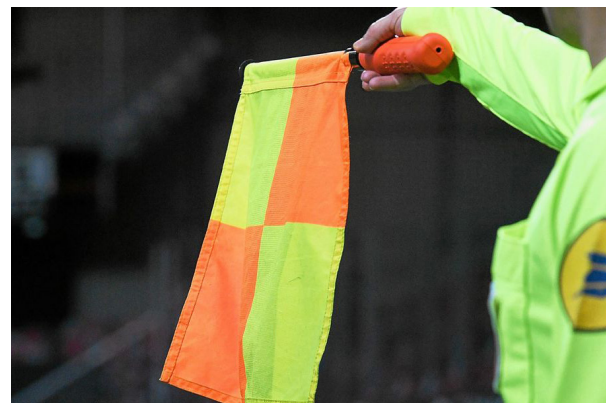

Comes with the hard shell bag allowing you to transport everything the safety kit

**Kit for 3 referees consisting of:**

- 2 flags for assistant referees
- 1 receiver for the central referee
- 1 cuff pouch
- 1 multi-wire cable for charging
- 1 USB adapter
- 1 hard shell bag
- 1 multilingual notice



Long range radio transmission. Battery life of 20 hours. Volume and vibrator adjustment on the armband box in 5 levels + OFF mode. Automatic flag standby. Vibrator and buzzer integrated into the flags. Charger supplied with 3-connector USB adapter for simultaneous charging of the flags and the armband box.

Reference: 063214

With ORANGE sleeves

Reference: 063214

With BLACK sleeves





**FOX CLASSIC WHISTLE**



**BLACK**

THE market reference +

Fox 40 whistle without little ball. Power: 115dB.

Reference: 063088 Unit



**FOX CLASSIC CMG® WHISTLE**



FOX whistle with connector. Same design than FOX classic large having a flexible connector for an easier catch in mouth. Power: 115dB.

Reference: 063136 Unit

**FOX SAFETY LANYARD**



Black colour. Sold without whistle.

Reference: 063090 Unit

**FOX CLASSIQUE MINI**



Smaller = less powerful = better indoor +

FOX whistle classic mini, with the same design than the large model, it makes a sound less powerful due to its smaller chamber. Perfect for indoor sports. Power: 109 dB.

Reference: 063366 Unit



**FOX WHISTLE SONIK CMG®**



Overpowered +

The most performing of superpowerful whistles, to use only outdoor, with a multidirectional sound 120 dB, without whistling, stable, regulated and very clear. It never get stuck and works in all weathers.

Reference: 063367 Unit



**FOX WHISTLE WITH FINGER CLIP**



Already adopted by many professionals, this technology allows excellent handling of the whistle due to ergonomics and pleasant materials. The fact that the whistle can be removed and put back on its magnetic base, will offers great freedom of movement. Device equipped with the "CLASSIC" whistle.

Reference: 063152 Unit

**FOX REFEREE PACK**



Pack consisting of a 'CLASSIC' whistle (115dB) + a 'SONIK CMG' whistle (120dB) + a 'PEARL' whistle (90dB) + a PILE or FACE coin + a safety cord. All components are stored in a durable and convenient zippered nylon carrying case.

Reference: 063151

**FOX FUZIUN © WHISTLE**



Ultra powerful whistle designed in 3 chambers allowing an optimal sound. Ergonomic design and soft tip for a perfect grip. Power: 118dB.

Reference: 063216 Unit

PLASTIC WHISTLE + LANYARD



Reference: 063193

Unit

BOX OF 12 PLASTIC WHISTLES



Reference: 062739

Box of 12

SET OF 12 LANYARDS



Reference: 062738

Set of 12 wrist lanyards

Reference: 063182

Set of 12 neck lanyards

FOOTBALL REFEREE WALLET AND SET OF SCORECARDS



This set contains 3 cards (1 red, 1 yellow and 1 white), a notebook of 15 scorecards and one pencil.

Ref: 063223 ① Set

Ref: 063277 ② Set of 15 scorecards

HANDBALL REFEREE WALLET AND SET OF SCORECARDS



This set contains 3 cards (1 red, 1 yellow and 1 white), a notebook of 15 scorecards and one pencil.

Ref: 063222 ① Set

Ref: 063278 ② Set of 10 scorecards

REFEREE BAG



Bag  
H. 19.5 cm  
L. 15.5 cm

It includes 1 red card - 1 yellow card - 1 white card - 1 notebook of 15 football scorecards - 1 notebook - 1 whistle with lanyard - 1 whistle - 1 two-sided piece - 1 wood pencil - 1 ballpoint - in a bag with several compartments and a zip.

Reference: 063292

Unit

REFEREE CARDS



LENGTH 11.2 cm  
WIDTH 7.7 cm

Available in 5 different colours.

Reference: 063265 Yellow, Red, White or Blue

Reference: 2024 NEW 063190 Orange

REFEREE PIECE



Piece heads or tails. Colour: Black / White.

Reference: 063307 Unit



REFEREE WATCH



Stopwatch watch combining ease of use and numerous features: stopwatch mode, countdown timer, alarm (dual), simple time display. With backlight and energy-saving mode. CR2032 battery included.

Reference: 024009 Unit

STOPWATCH WATCH



1 timing line - Accuracy 1/100 sec - Timing time: 24H 12-24H clock / alarm / date mode - Countdown timer mode - Backlighting of the screen - Splash proof - Dial diameter 50mm - Digit height: 10/4 mm . - 63 gr.

Reference: 024001 Unit

ELECTRONIC WHISTLE



Electronic whistle with manual control. This kind of article is voted in by physical education teachers because it is more hygienic. 2 different tones. Ergonomic design, light and robust. Delivered with cordon. Powered by 4 x LR44 batteries, not included. Decibel: max.110 DB.

Reference: 063485

DOUBLE-SIDED SUBSTITUTION BOARD



DOUBLE SIDED



Mode player substitution and additional time +

|                     |        |        |
|---------------------|--------|--------|
| RECYCLED RECYCLABLE |        |        |
| LENGTH              | HEIGHT | WEIGHT |
| 55 cm               | 26 cm  | 2.6 kg |

Double-sided player substitution board with LED lights. Offers 2 operating modes: player substitution with incoming and outgoing numbers from 0 to 99, or additional time from 0 to 99 minutes. High visibility (120 m) with digits measuring 18 x 10 cm. Can also be used as a scoreboard. Lithium battery, supplied with charger. Battery life: 5 hours of use.

Reference: 068003 Unit

ELECTRONIC SCOREBOARD DISPLAY / PLAYER SUBSTITUTION



PLAYER CHANGE PANEL



ADDITIONAL TIME MODE

|                     |        |        |
|---------------------|--------|--------|
| RECYCLED RECYCLABLE |        |        |
| LENGTH              | HEIGHT | WEIGHT |
| 55 cm               | 26 cm  | 2 kg   |

Single-sided LED player-change panel. 2 modes : either player changeover with in/outcoming numbers (from 0 to 99), or additional time from 0 to 9 min. High visibility (120 m) - Digit size = 18 x 10cm. Can be used as a scoreboard. Lithium battery, delivered with charger. Autonomy: 5 hours.

Reference: 068001N Unit

MANUAL PLAYER CHANGE SYSTEM



|          |          |
|----------|----------|
| The set  | 1 number |
| L. 40 cm | L. 14 cm |
| H. 31 cm | H. 27 cm |

Two-sides player change system. Numbering from 0 to 99 on each face thanks to reversible black/yellow or black/orange pallets. Neon color for higher visibility.

Reference: 062797 Unit

MULTI-FUNCTION DISPLAY



Customizable text



With carrying handle

Visible and audible at 90m



Hook and fixing chain

**SCORE DISPLAY:**

- Team customization on 4 characters and score up to 199.



**CLOCK:**

- Auto synchronisation with your phone



**SEGMENT TIMER:**

- Schedule sequences with work time and rest time
- Possibility to program several work sequences with several stages
- Display of stages and count-down-time



**STOPWATCH:**

- Accuracy in hours/minutes/seconds



**COUNT:**

- Set the time to 99 minutes and 59 seconds. The alarm will sound at 0.



Easy and intuitive handling

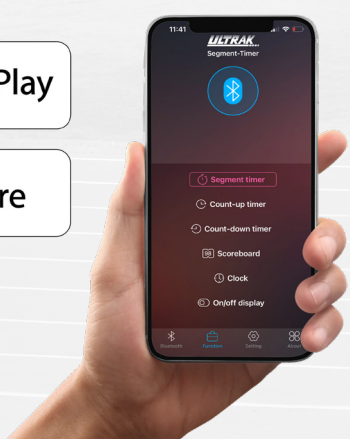

Discover more



| LENGTH | HEIGHT | WEIGHT |
|--------|--------|--------|
| 55 cm  | 26 cm  | 2 kg   |

With these large LED figures of 31.8cm in height and its adjustable sound power, it is visible and audible at 90m. It can be programmed and controlled by the supplied remote control or a smartphone via the «SEGMENT TIMER» application, which can be downloaded on iOS or Android. Control range: 20m (remote and smartphone by Bluetooth). Autonomy of 7h (rechargeable thanks to its charger provided). Equipped with 2 removable feet, it can be placed on a table or suspended thanks to its hooks and its 2 chains of 55 cm included.

Reference: 024216

Unit



**SPORTBEEPER PRO**

2 years warranty



*New Sportifrance own brand!*

**SportBeeper**

A benchmark in the field of coaching and physical conditioning, SportBeeper has been equipping professionals and amateurs for over 20 years. Designed in France using short supply chains, it is a tool that combines expertise with eco-responsibility.

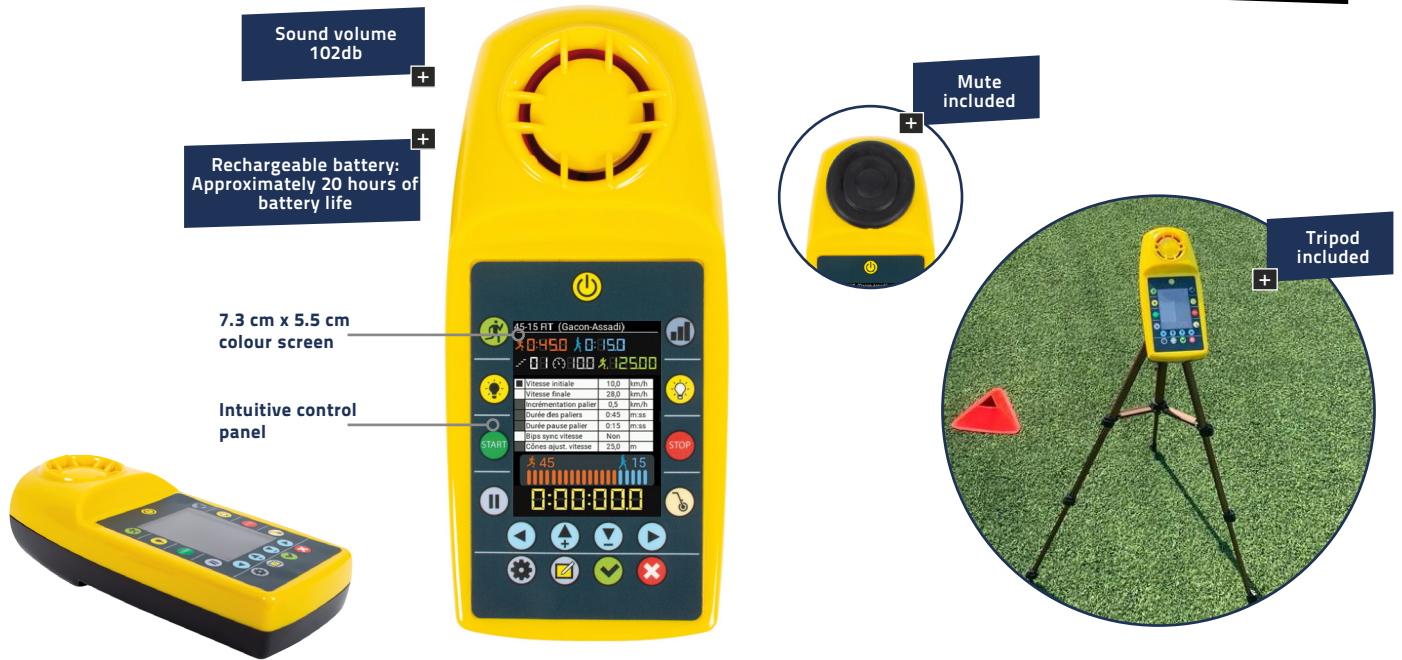

**What is it?**

It is a tool designed to ensure sequential and audible control of exercises or tests. It helps manage time, pace, and training phases, freeing the coach from timekeeping and whistle blowing.

**To do what?**

Conduct tests, follow a pace, respect precise timings (intervals or repetitions), link sets together, and structure training sessions.

**Who is it for?**

Teachers, coaches, fitness practitioners, runners.



**Examples of possible tests:**

VAM-EVAL (Cazorla) / Shuttle run (Leger) / Cooper / Time to exhaustion at MAS / Conconi / Probst, and many others.

**Possible training formats:**

Cyclic / Bicyclic / Combined / Paced 3.6<sup>o</sup> Gacon / Constant pace / Progressive pace / Progressive stages / Progressive stages in blocks / Timer.

Discover More



| WEIGHT | LENGTH | WIDTH | HEIGHT |
|--------|--------|-------|--------|
| 430 g  | 24 cm  | 11 cm | 7.3 cm |

SportBeeper is the ideal tool for ensuring sequential and audible control of exercises, freeing the coach from tedious whistle blowing so they can focus exclusively on leading the session without losing sight of athletes in action. It is an intuitive, easy-to-use tool with long battery life (approximately 20 sessions of 2 hours).

Reference: 024300

The complete kit (SportBeeper Pro + tripod + mute + cable + adaptor)

Reference: 024302

The tripod alone



3D COACH CLIPBOARD FOOTBALL



DELIVERED ON INDIVIDUAL PACKAGING EASY TO PUT ON DISPLAY



RECYCLED RECYCLABLE  
LENGTH 36 cm WIDTH 22.5 cm

Tactical board, erasable, rigid, in PVC with a clipboard, one side with the whole pitch and one side with a half-pitch. Delivered with a marker.

Reference: 063200 FOOTBALL

3D COACH CLIPBOARD HANDBALL / FUTSAL

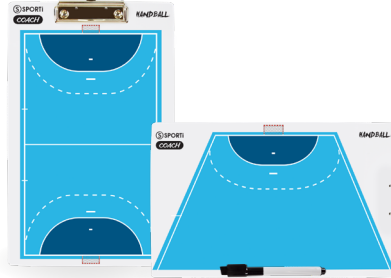

RECYCLED RECYCLABLE  
LENGTH 36 cm WIDTH 22.5 cm

Tactical board, erasable, rigid, in PVC with a clipboard, one side with the whole pitch and one side with a half-pitch. Delivered with a marker.

Reference: 063201 HANDBALL / FUTSAL

TAKTIFOL

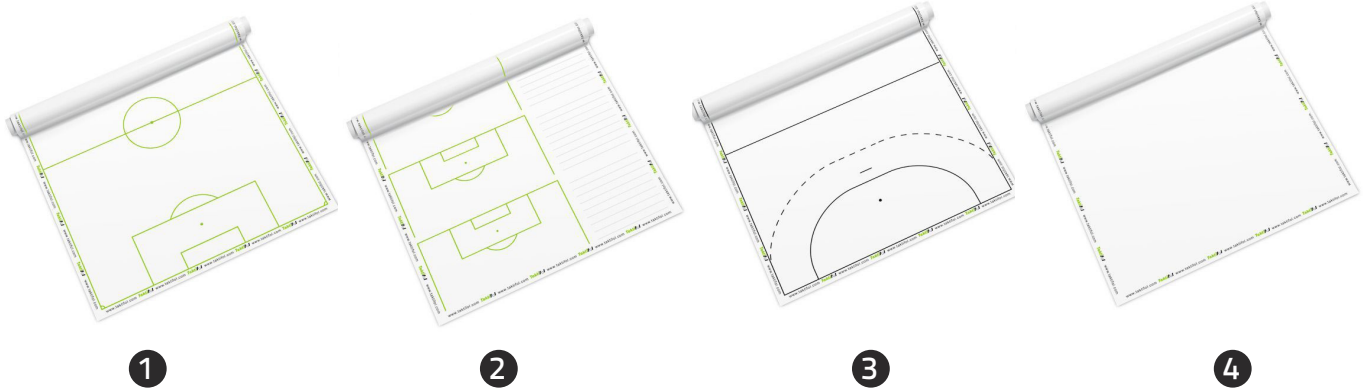

| Sheet size |       |
|------------|-------|
| W.         | 60 cm |
| L.         | 80 cm |

Delivered in individual packaging with barcode



Practical use, easy to carry, the Taktifol can be used on any smooth surface (window, cloakroom door, wall, etc.). Dry-erasable and reusable. Roller of 60 cm in width and 20 m in length composed of 25 detachable pages. Exist in FOOTBALL, HANDBALL/FUTSAL, BASKETBALL, RUGBY and UNIVERSAL version. Delivered without carrying bag and pen.

- Reference: 063293 1 FOOTBALL
- Reference: 063299 2 FOOTBALL / PENALTY AREA
- Reference: 063294 3 HANDBALL / FUTSAL
- Reference: 063297 4 UNIVERSAL

ACCESSORIES



Carrying bag with side pockets to store your accessories, cleaning cloth and set of 2 pencils.

- Reference: 063301 1 Set of two pencils (1 Red / 1 Black)
- Reference: 063305 2 Carrying bag and cleaning cloth
- Reference: 063472 3 Football notepad

TAKTI-FOOT KIT



Composed of a roll of 25 Taktifol football sheets + 2 pencils (1 red and 1 black) + 1 notepad + 1 cleaning cloth + a suitable carrying bag.

Reference: 063470 Kit



LCD COACHING TABLET 16" KIT



Available in Football, Basketball, Handball and Futsal version

|            |
|------------|
| 16" size   |
| w. 23.5 cm |
| L. 33 cm   |



Set composed of a LCD tablet 16", a 16" tablet bag, a magnetic writing stylus, an erasable pen and a type-C standard USB cable.

Reference: 063049 FOOTBALL  
Reference: 063050 HANDBALL / FUTSAL

LCD COACHING TABLET 21" KIT



Available in Football, Basketball, Handball and Futsal version

|            |
|------------|
| 21" size   |
| w. 30.6 cm |
| L. 45.5 cm |



Set composed of a LCD tablet 21", a 21" tablet bag, a magnetic writing stylus, an erasable pen and a type-C standard USB cable.

Reference: 063052 FOOTBALL  
Reference: 063055 HANDBALL / FUTSAL

LCD COACHING TABLET SPORTI



|            |
|------------|
| 16" size   |
| w. 23.5 cm |
| L. 33 cm   |

|            |
|------------|
| 21" size   |
| w. 30.6 cm |
| L. 45.5 cm |



FOOTBALL  
(Available in 16" and 21")



HANDBALL / FUTSAL  
(Available in 16" and 21")

2 sizes available



Tablet with 2 LCD screen functions. Locking and unlocking of the screen. Instant-erase. With dry-erase whiteboard on the back. Supplied with a magnetic stylus and an erasable pen. To charge the tablet, use a DC 5V charger not supplied, with a type C standard USB cable included.

LCD coaching tablet Sporti 16"

Reference: 063037 FOOTBALL 16" / 33 x 23.5cm  
Reference: 063038 HANDBALL / FUTSAL 16" / 33 x 23.5cm

LCD coaching tablet Sporti 21"

Reference: 063040 FOOTBALL 21" / 45.5 x 30.6cm  
Reference: 063041 HANDBALL / FUTSAL 21" / 45.5 x 30.6cm

LCD TABLET BAG



Bag for carrying and protecting your LCD tablets. Material: polyester 420D. 2 sizes available. Tablet bag 16": 27x36cm. Tablet bag 21": 33x48cm.

Reference: 063045 Tablet bag 16"  
Reference: 063046 Tablet bag 21"

STYLUS FOR LCD TABLET



Magnetic stylus



Bag for carrying and protecting your LCD tablets. Material: polyester 420D. 2 sizes available. Tablet bag 16": 27x36cm. Tablet bag 21": 33x48cm.

Reference: 063019 Stylus for LCD tablet

SPIRAL COACH NOTEBOOKS FOOTBALL



Spiral coach notebook for 100 games and / or training sessions (100 pages - Front / back printing).

Reference: 063464 A5  
Reference: 063465 A4

SPIRAL COACH NOTEBOOKS HANDBALL / FUTSAL



Spiral coach notebook for 100 games and / or training sessions (100 pages - Front / back printing).

Reference: 063466 A5  
Reference: 063467 A4

PRO COACHING BOARD HANDBALL / FUTSAL



Composed of a magnetic pitch. Delivered with a pencil case containing pieces, 2 pens, one felt pen with a brush and one duster. The other section contains 25 detachable pages for your schemes and your notes. With zip.

Reference: 063449 HANDBALL / FUTSAL With 10 red pawns, 10 blue pawns and 1 black pawn

PRO COACHING BOARD FOOTBALL



Composed of a magnetic pitch. Delivered with a pencil case containing pieces, 2 pens, one felt pen with a brush and one duster. The other section contains 25 detachable pages for your schemes and your notes. With zip.

Reference: 063306 FOOTBALL With 13 red pawns, 13 blue pawns and 1 black pawn

• RIGID BRIEFCASE N°2



Perfect around an outdoor sport ground, it protects your files from rain and wind. You can put your notebooks of A4 format inside. It has a metallic clip and a hinge on the right side. Colour: Black.

Reference: 063461 Unit

• PRO RIGID BRIEFCASE



Composed of 2 compartments that you can open with a hinge at the top and which has a metallic clip. The bottom compartment is big and deep enough for a notebook of an A4 format. The top compartment, flatter can also have your papers of an A4 format. It has a transparent lid. It can be used with dry-erasable markers (delivered without pencil). Colour: Grey/Green.

Reference: 063463 Unit



**LARGE DOUBLE-SIDED BOARD HAND / FUTSAL  
60X90CM**

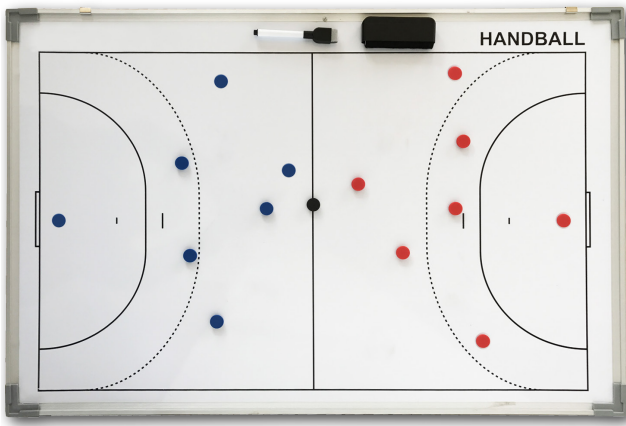

Rigid tactical board, with on one side a whole handball pitch and on the other side a half-pitch. Delivered with its carrying bag, its magnets (7 blue, 7 red and 1 black), a brush, a felt pen and a sachet.

Reference: 063443

Unit

**TWO-SIDED FOOTBALL LARGE BOARD 60X90 CM**

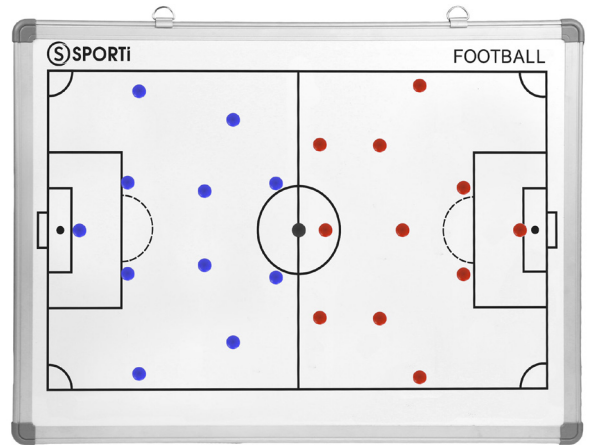

Wall tactical board, rigid, with on one side a whole football pitch and on the other side a half-pitch. Delivered with a carrying bag, magnets (12 blue, 12 red and 1 black), a brush, a felt pen and a sachet.

Reference: 063437

Unit

**SMALL DOUBLE-SIDED BOARD HAND / FUTSAL  
30X45CM**

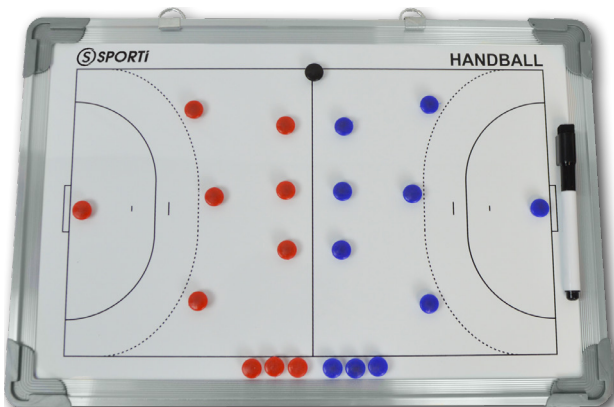

Rigid tactical board, with on one side a whole handball pitch and on the other side a half-pitch. Delivered with its carrying bag, its magnets (10 blue, 10 red and 1 black), a brush, a felt pen and a sachet.

Reference: 063447

Unit

**TWO-SIDED FOOTBALL SMALL BOARD 30X45 CM**



Wall tactical board, rigid, with on one side a whole football pitch and on the other side a half-pitch. Delivered with a carrying bag, magnets (11 blue, 11 red and 1 black), a brush, a felt pen and a sachet.

Reference: 063253

Unit



**FOLDABLE MAGNETIC BOARD**



+ 2 available sizes



Unfolded view



| Folded size |       | Unfolded size |        |
|-------------|-------|---------------|--------|
| w.          | 60 cm | w.            | 120 cm |
| L.          | 90 cm | L.            | 90 cm  |

RECYCLABLE

Board easy to use, transportable thanks to its handle. Delivered without magnetic pawn.

Reference: 063445A 45 x 60 cm  
Reference: 063445B 60 x 90 cm

**TRIPOD FOR BOARD**



RECYCLABLE  
MAX HEIGHT  
80 cm

Aluminum tripod to facilitate the installation of your tactical boards in changing rooms or meeting rooms. With its very compact storage bag, it will be the ideal partner for your travels.

Reference: 063491 Unit

**WHITE TACTIC BOARD**



RECYCLABLE  
LENGTH 90 cm  
WIDTH 60 cm

Blank rigid tactic board. Support base to put your pencils, magnets, etc. is included. Delivered without accessories.

Reference: 063210 Unit

**PIVOTABLE WHITEBOARD ON WHEELS**



DEPTH 55 cm  
WIDTH 126 cm  
HEIGHT 173 cm

RECYCLABLE

Double-sided pivotal whiteboard on wheels with brake. Easy to move to set up your meeting rooms or club houses. This whiteboard pivots and holds in place thanks to a clip system. The writing surface is magnetic and dry erasable. It is fitted with a marker holder over the length.

Reference: 063490 Unit

**MAGNETIC PAWN**



RECYCLED  
RECYCLABLE  
DIAMETER 2 cm

Available in Red, Blue and Black.

Reference: 063444 Unit

**WHITE CLIPBOARD CLEANER**



VOLUME 200 ml

Product specially designed for the regular maintenance of white boards, screens, laminated surfaces, mobile phones and so on. It removes the permanent felt-tips marks. Without fragrance.

Reference: 063343 Unit

**SINGLE CARRYING BAG**



Format 60x90 cm compatible with: 063437, 063443, 063360.



Format 30x45 cm compatible with: 063253, 063446 et 063447.

RECYCLED  
RECYCLABLE

Reference: 063244 For board 30x45cm  
Reference: 063239 Forboard 60x90cm



FIRST-AID JUNIOR BAG

**Prestoglas**

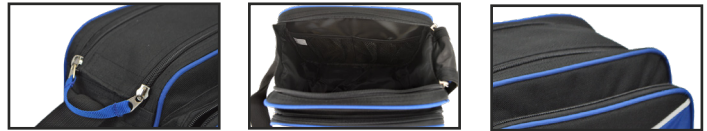

Label space for the team's name

| LENGTH | WIDTH | HEIGHT |
|--------|-------|--------|
| 24 cm  | 15 cm | 18 cm  |

100% polyester first-aid bag junior 600 deniers easy to transport thanks to its strap. It is composed of 2 compartments: one main compartment easily accessible thanks to his double zip and an outside pocket.

Reference: 078104

Unit

FULL FIRST-AID CLUB KIT



FULL FIRST-AID CLUB JUNIOR HEALER BAG



Kit composed of 1 set of 10 sterile compresses, 1 cold spray 400 ml, 1 roll of adhesive plaster, 1 dressing strip to cut, 1 pair of scissors, 1 stretch bandage, 1 crepe strip, 1 pair of protective gloves and 1 set of 10 70° alcohol wipes.

Reference: 066153

Unit

First-aid bag junior 24 cm filled of a first-aid kit club reference 066153.

Reference: 066184

Unit

FIRST-AID BAG

**SPORTi**



Plasticised and zipped compartments to keep your products clean

| LENGTH | WIDTH | HEIGHT |
|--------|-------|--------|
| 17 cm  | 6 cm  | 22 cm  |

100% polyester first-aid bag 600 deniers composed of 2 compartments and a flap. One of the compartments is plasticised and zipped to keep your products sheltered from possible dirt and the other is equipped with a net to faster access to the products. The flap has small pockets in order to store scissors, splinter tweezers and other material not bulky.

Reference: 078071

Unit

FULL FIRST-AID CLUB KIT



First-aid kit filled of a kit club reference 066153.

Reference: 066155

Unit

**FIRST-AID CLUB HEALER BAG**

**Prestoglas**



| LENGTH | WIDTH | HEIGHT |
|--------|-------|--------|
| 38 cm  | 24 cm | 24 cm  |

100% polyester first-aid bag CLUB 600 deniers. Easy to transport thanks of its strap and very easy use for all your senior teams. It is composed of 3 compartments:  
 -one main compartment with removable separations and an easy access to the products facilitate by a large double zip.  
 -an isothermal compartment allowing to store Cryo products like cold packs.  
 -a large zipped pocket with several compartments.

Reference: 078105 Unit

**FIRST-AID CLUB PRO HEALER BAG**

**Prestoglas**



| LENGTH | WIDTH | HEIGHT |
|--------|-------|--------|
| 47 cm  | 23 cm | 28 cm  |

This bag has the same kit than the CLUB bag, but it is larger therefore this PRO bag will allow you to offer your team a large product range to increase the comfort of your players.

Reference: 078106 Unit

**FULL FIRST-AID CLUB HEALER BAG**



First-aid bag club filled of a first-aid kit club reference 066156.

Reference: 066157 Unit

**FULL FIRST-AID CLUB PRO HEALER BAG**



First-aid bag PRO filled of a first-aid kit PRO reference 066181.

Reference: 066182 Unit

**FIRST-AID CLUB HEALER KIT**



Kit composed of 1 cold spray 400 ml, 2 cold packs at single use, 1 dressing strip to cut, 1 box of 20 dressings, 3 packets of 3 stitches, 1 set of 10 sterile compresses, 1 roll of adhesive plaster, 1 pair of scissors, 1 splinter tweezers, 1 stretch bandage, 1 crepe strip, 1 pair of protective gloves, 1 survival blanket, 1 set of 10 70° alcohol wipes, 1 elastic adhesive strip of 6 cm, 1 elastic adhesive strip (blue) 7.5 cm x 4.5 m and 1 flask of 100 ml of 70° alcohol.

Reference: 066156 Unit

**FIRST-AID CLUB PRO HEALER KIT**



This kit is composed of 2 cold sprays 400 ml, 2 cold packs at single use, 1 dressing strip to cut, 1 box of 20 dressings, 5 steri strip packets of 3 stitches, 1 set of 10 sterile compresses, 1 roll of adhesive plaster, 1 pair of scissors, 1 splinter tweezers, 2 stretch bandages, 2 crepe strips, 2 pair of protective gloves, 1 survival blanket, 1 set of 10 70° alcohol wipes, 1 set of 10 Chlorhexidine wipes, 1 elastic adhesive strip 3 cm, 2 elastic adhesive strips 6cm, 1 elastic adhesive strip 8 cm, 1 (blue) elastic cohesive strip 7.5 cmx4.5 m, 1 flask of 100 ml of 70° alcohol, 1 camphor oil of 250 ml, 1 heating gel of 150 ml, 1 arnica gel 250 ml, 1 oriental balm of 100 ml.

Reference: 066181 Unit



• ICE BOX ON WHEELS 55L

**Prestoglas**



| VOLUME | LENGTH | WIDTH | HEIGHT |
|--------|--------|-------|--------|
| 55 L   | 49 cm  | 44 cm | 52 cm  |

RECYCLABLE

Its telescopic handle and large wheels will make it easier to transport and keep your drinks or cryotherapy devices cool on any pitch. The lid has 4 cup slots and a drain plug at the back of the cooler, letting you empty out the melted ice. Colour: Blue.

Reference: 066006

Unit

COOL BOX 10L

**Prestoglas**



| VOLUME | LENGTH | WIDTH | HEIGHT |
|--------|--------|-------|--------|
| 10 L   | 33 cm  | 22 cm | 31 cm  |

RECYCLABLE

Rigid cool box allowing to keep the cold packs or ice bags cold.

Reference: 066001

Unit

TREATMENT KIT N°1



Composed of 6 cold sprays 400 ml, 10 cold packs at single use, 3 sets of 10 sterile compresses (so 30 compresses), 6 rolls of adhesive plaster, 6 dressing strips to cut 6 cm x 50 cm, 6 flasks of 100 ml of 70° alcohol and 6 crepe strips.

Reference: 066158

Unit

TREATMENT KIT N°2



Treatment kit promo 1 + 6 elastic adhesive strips 6 cm + 6 blue elastic adhesive strip 7.5 cm x 4.5 m.

Reference: 066159

Unit

KIT PHARMA STOCK CLUB

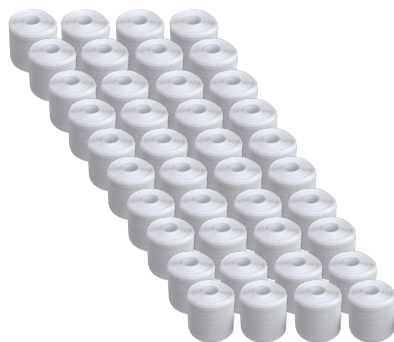

Composed of 12 cold sprays + 40 elastic adhesive strips 6 cm + 24 instant cold packs.

Reference: 066129

Unit

**COLD SPRAY  
150 ML**



**Prestoglas**



Packaging:  
box of 12

**VOLUME**  
150 ml

Immediate action. Classic spray with the Prestoglas quality. Conceived to ease the post-traumatic pain by the cold. It reduces the sensation of pain.

Reference: 066167 Unit

**COLD SPRAY  
400 ML**



**Prestoglas**



Packaging:  
box of 12

**VOLUME**  
400 ml

Immediate action. Classic spray with the Prestoglas quality. Conceived to ease the post-traumatic pain by the cold. It reduces the sensation of pain.

Reference: 066110 Unit

**COLD SPRAY WITH  
ARNICA 400 ML**



**Prestoglas**



Packaging:  
box of 12

**VOLUME**  
400 ml

Immediate action. Cold spray with arnica to improve efficiency.

Reference: 066168 Unit

**INSTANT COLD PACK**

**Prestoglas**



Packaging:  
box of 28

**LENGTH**  
18 cm

**WIDTH**  
15 cm

Instant cold by pressure essential in all sports club to treat the knocks or muscular incidents.

Reference: 066008 Unit

• **STRETCHER**



**FOLDED**

| WEIGHT | LENGTH   | WIDTH | HEIGHT |
|--------|----------|-------|--------|
| 5.2 kg | 205,5 cm | 53 cm | 13 cm  |

Folding stretcher double folded across the width. Feet, retractors and aluminium handles. Nylon coating covering with PVC. Fire and water resistance. Washable.

Reference: 066186 Unit

**NASAL PROTECTIVE HELMET**



Used to protect after rhinoplasty, like protection against impacts in sport. This universal helmet of single-size in polycarbonate thermoformed has elastic straps to ensure the exact adjustments on the face.

Reference: 066002 Unit

**ICE BAG**



**LENGTH**  
15 cm

Hermetic closure. It eases pains linked to shock.

Reference: 066012 Unit

**SET OF 6 HEAT PATCHES**



Set of 6 heating patches at essential oils of dimensions 16 cm x 11 cm at single use, in flesh-coloured elastic adhesive fabric, at oleocapsicum oil (1%). Individual vacuum pack. Set of 6.

Reference: 066172 Set

**REUSABLE HOT/COLD COMPRESS  
10X10 CM**



Soft fabric and comfortable and gel small cushion which hugs body part's figure to treat. Set of 6 compresses of dimensions 10x10 cm.

Reference: 066166 Unit  
Reference: 066143L Set of 6

**REUSABLE HOT/COLD COMPRESS  
10X26 CM**



Reusable gel small cushion. Delivered with an anti-irritation and non-woven cover to increase comfort. Box of 6 compresses of dimensions 10x26 cm.

Reference: 066165 Unit  
Reference: 066142L Set of 6



**WARM-UP GEL**  
**Prestoglas**



VOLUME  
150 ml

It allows to get quickly a durable warm feeling during physical preparation.

Reference: 066127

**ARNICA CRYO GEL**  
**Prestoglas**



VOLUME  
150 ml

Ideal for sports recovery. This gel relieves and soothes muscles after effort. Intense cold sensation.

Reference: 066128

**ANTI-FRICTION CREAM**  
**Prestoglas**



VOLUME  
150 ml

Anti-friction cream will allow you to protect your skin against irritations and to avoid having red patches and blisters.

Reference: 066126

**ARNICA CREAM**  
**Prestoglas**



VOLUME  
150 ml

Ideal for sports recovery. This gel relieves and soothes muscles after effort.

Reference: 066100

**MASSAGE OIL WITH ARNICA**  
**Prestoglas**



100ML.

250ML.

+ 100% natural

Vegetable massage oil in which Arnica macerated during 4 weeks (therefore it has a maximum concentration in Arnica), is perfect for preparation and muscular recovery.

Reference: 066178A 100 ml.  
Reference: 066178B 250 ml.

**CAMPHORATED MASSAGE OIL**  
**Prestoglas**



250ML.

500ML.

+ Advantage: content in superior camphor at standard

Its enjoyable texture and its camphoric smell, will be useful during massages as part of physical preparation. It allows to obtain quickly a warm feeling.

Reference: 066161A 250 ml  
Reference: 066161B 500 ml

**ORIENTAL BALM 100ML**  
**Prestoglas**



VOLUME  
100 ml

Coming from the balm Thai, its content in essential oils is less concentrated but has the same components. It allows you to massage more widely. As effective to prepare muscles to effort as to ease them. You need to have this product in your first-aid bag.

Reference: 066164 Unit

**CATAPLASM WITH CLAY 500 ML**  
**Prestoglas**



VOLUME  
500 ml

Cataplasm made from Kaolin of mentholated high quality. To use alone or with a plastic film. Perfect for an active recovery after the effort and to prevent aches.

Reference: 066179 Unit

**VASELINE 500ML**  
**Prestoglas**



VOLUME  
500 ml

To avoid the effects of the warm-up and the rubbings on the sensitive areas.

Reference: 066171 Unit

**STRETCH FILM REEL**  
**Prestoglas**



Film size  
w. 12.5 cm  
L. 200 m

Transparent stretch film 17 micrometres. To wrap the cataplasm or the application gel.

Reference: 066180 Unit

**VELPEAU STRAPP BANDAGE**



Packaging:  
3cm : box of 24  
6cm : box of 18  
8cm : box of 12

RECYCLED  
LENGTH  
2.5 m

Elastic adhesive bandage. Very strong holding on the skin and high skin tolerance. Bandage WITHOUT LATEX.

- Reference: 066120 3cm x 2.5m
- Reference: 066121 6cm x 2.5m
- Reference: 066122 8cm x 2.5m

**ELASTIC ADHESIVE BANDAGE**



One of the best value for money of the market

Packaging:  
3cm : box of 80  
6cm : box of 40  
8cm : box of 80

LENGTH  
2.5 m

Elastic bandage of white colour. For flexible immobilisations, 100 % cotton, resistant and hypoallergenic. It is very adhesive and extensible of about 50%.

- Reference: 066107 3cm x 2.5m
- Reference: 066108 6cm x 2.5m
- Reference: 066109 8cm x 2.5m

**SPORT TAPE**



LENGTH 5 m  
WIDTH 5 cm

Elastic adhesive bandage, used to preventing injuries, offer a mechanical support to muscles, align the body and reduce inflammations. Waterproof and breathing. Available in colours: black, blue, red and beige.

- Reference: 066138 5cm x 5m

**ELASTIC COHESIVE BANDAGE**



LENGTH 4.5 m  
WIDTH 7.5 cm

Elastic cohesive bandage 80 % polyester and 20 % elastane. It sticks on itself and not directly on the skin. For flexible immobilisations or compressions. It can also be used to hold the cold packs. Colour: blue.

- Reference: 066005 Unit

**NON-ELASTIC ADHESIVE BANDAGE**



Packaging:  
2.5cm: box of 36  
4cm: box of 24

LENGTH 10 m

Used for the conception of the rigid joint immobilisations. Important stickiness extended. Divisible by hand. 10 m length. Available in 2 widths (2.5 cm and 4 cm).

- Reference: 066003A 2.5cm x 10m
- Reference: 066003B 4cm x 10m

**PROTECTIVE FOAM**



LENGTH 27 m  
WIDTH 7 cm

Elastic sub-bandage, protective foam of the skin and hair system. Auto-adhesive. Divisible by hand. Colour: beige.

- Reference: 066140 Unit

**STERILE COMPRESSES**



Folded size  
w. 7.5 cm  
L. 7.5 cm

Unfolded size  
w. 30 cm  
L. 30 cm

Set of 10 compresses, packed individually.

- Reference: 066022 Unit

**MEDICAL ADHESIVE TAPE**

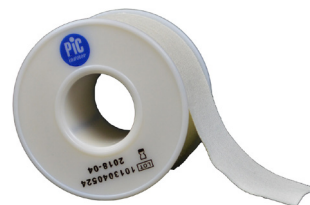

LENGTH 5 m  
WIDTH 2.5 cm

- Reference: 066115 Unit

**STERIL ADHESIVE SUTURES**



PACK OF 3 ADHESIVE SKIN CLOSURES

- Reference: 066116

**FABRIC DRESSING STRIP**



WIDTH 50 cm  
HEIGHT 6 cm

Dressing strip to cut.

- Reference: 066113 Unit

**BOX OF 20 SORTED DRESSINGS**



Box of 20 assorted dressings (8 in 19x72 mm, 4 in 25x72 mm, 4 with a diameter of 22.5 mm and 4 in 57x16 mm).

- Reference: 066114 Unit

**BOX OF 20 AQUABLOC DRESSINGS**



Box of 20 assorted AQUABLOC dressings (8 in 19x72 mm, 4 in 25x72 mm, 4 with a diameter of 22.5 mm and 4 in 57x16 mm). Breathable and waterproof dressings.

- Reference: 066137 Unit



**SET OF 10  
70° ALCOHOL WIPES**



RECYCLABLE

Set of 10 70° alcohol wipes, cleaner and disinfectant.

Reference: 066073

**SET OF 10  
CHLORHEXIDINE WIPES**



RECYCLABLE

Set of 10 Chlorhexidine wipes, cleaner and disinfectant without alcohol.

Reference: 066074

**SET OF 10  
CALENDULA WIPES**



RECYCLABLE

Set of 10 Calendula wipes, soothing solution for knocks.

Reference: 066075

**ARNICA PACK SET OF  
3X3 PODS OF 0.8 ML**



Texture developed to penetrate without let an oily skin.

Reference: 066151

**70° ALCOHOL 100 ML**



VOLUME  
100 ml

It allows to clean and disinfect the area to treat. Spray.

Reference: 066149

Unit

**100ML CHLORHEXIDINE**



VOLUME  
100 ml

It allows to clean and disinfect the area to treat. Without alcohol. Spray.

Reference: 066150

Unit

**ABSORBENT COTTON**



Packet of 100 gr of absorbent cotton.

Reference: 066148

Unit

**NASAL PLUGS**



Packet of 40 cotton nasal plugs to stop nose bleeds.

Reference: 066147

Packet

**CREPE BANDAGE**



LENGTH  
4 m    WIDTH  
7 cm

Reference: 066119

Unit

**ELASTIC BANDAGE**



LENGTH  
3 m    WIDTH  
7 cm

Reference: 066117

Unit

**SPLINTER TWEEZERS**



Splinter tweezers with pointed tips of 11 cm. Sold by the unit.

Reference: 066032

**PAIR OF SCISSORS**



Reference: 066123

**SURVIVAL BLANKET**



LENGTH  
210 cm    WIDTH  
160 cm

Survival blanket (gold/silver).

Reference: 066029

**VINYL GLOVES**



Vinyl gloves. Sold per pair.

Reference: 066124

**PRO BOTTLE CARRIER SMALL MODEL**



Monobloc bottle carrier very robust which can have up to 8 bottles.

Reference: 062768 Unit

**PRO BOTTLE CARRIER LARGE MODEL**



Monobloc bottle carrier very robust which can have up to 12 bottles.

Reference: 062769 Unit  
Reference: 062775 The shoulder strap

**PRO BOTTLES CARRIER SMALL MODEL + 8 BOTTLES 600ML**



Very robust monobloc bottle carrier with 8 bottles 600ml.

Reference: 062794 Kit

**PRO BOTTLES CARRIER SMALL MODEL + 8 BOTTLES 800ML**



Very robust monobloc bottle carrier with 8 bottles 800ml.

Reference: 062795 Kit

**PRO BOTTLES CARRIER LARGE MODEL + 12 BOTTLES 600ML**



Large model PRO bottle carrier + 12 bottles 600ml.

Reference: 062791 Kit

**PRO BOTTLES CARRIER LARGE MODEL + 12 BOTTLES 800ML**



Large model PRO bottle carrier + 12 bottles 800ml.

Reference: 062792 Kit



750ML BOTTLE

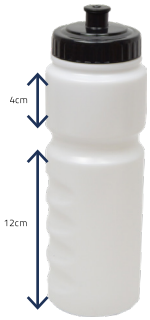

Screw cap. Transparent strip showing the water level. Colour: white.

Reference: 062744 Unit

600ML BOTTLE



Lightweight and easy-squeeze bottle. Ergonomic cap with large and soft drinking valve. Made of 100% BPA, BPS and BPF free polypropylene.

Reference: 062780 Unit

800ML BOTTLE



Lightweight and easy-squeeze bottle. Ergonomic cap with large and soft drinking valve. Made of 100% BPA, BPS and BPF free polypropylene.

Reference: 062781 Unit

800ML HYGIENIC BOTTLE TEAM



800ml hygienic cork to avoid contact with mouth. Transparent strip to see the water level.

Reference: 062782 Unit

PVC BOTTLE CARRIER LARGE MODEL



Monobloc bottle carrier very robust which can have up to 8 bottles. Main face allowing to put a sticker with the name of the club, of the team or a sponsor.

Reference: 063165 Unit

PVC BOTTLES CARRIER-LARGE MODEL + 8 BOTTLES 600ML



Large model PVC bottle carrier + 8 bottles 600ml.

Reference: 062788 Kit

PVC BOTTLES CARRIER-LARGE MODEL + 8 BOTTLES 800ML



Large model PVC bottle carrier + 8 bottles 800ml.

Reference: 062789 Kit

PVC BOTTLES CARRIER-LARGE MODEL + 8 HYGIENIC BOTTLES 800ML



Large model PVC bottle carrier + 8 bottles team 800ml.

Reference: 062790 Kit

PVC BOTTLE CARRIER SMALL MODEL



Foldable. Central carry handle. In robust PVC. Main face allowing to put a sticker with the name of the club, of the team or a sponsor.

Reference: 063163 Unit

PVC BOTTLES CARRIER - SMALL MODEL + 6 BOTTLES 600 ML



Small model PVC bottle carrier + 6 bottles 600 ml.

Reference: 062785 Kit

PVC BOTTLES CARRIER - SMALL MODEL + 6 BOTTLES 800 ML



Small model PVC bottle carrier + 6 bottles 800 ml.

Reference: 062786 Kit

PVC BOTTLES CARRIER - SMALL MODEL + 6 HYGIENIC BOTTLES 800 ML



Small model PVC bottle carrier + 6 bottles team 800 ml.

Reference: 062787 Kit

PAINT



|                        | CLUB                                                      | ELITE                                          | ELITE PRO                                                                                               | COLOUR                         |
|------------------------|-----------------------------------------------------------|------------------------------------------------|---------------------------------------------------------------------------------------------------------|--------------------------------|
| USE                    | On grass training pitches regularly delineated.           | For all types of pitches, honour and training. | High performance paint, which covers very well. Resist to bad weather and intensive passage of players. | For grass training pitches.    |
| TRACING MODE           | Roller machine                                            | For roller or spraying machine                 | For roller or spraying machine                                                                          | For roller or spraying machine |
| WEIGHT                 | 15 Kg                                                     | 15 Kg                                          | 15 Kg                                                                                                   | 12 Kg                          |
| CAPACITY               | 4 to 5 tracings                                           | 4 to 5 tracings                                | 4 to 5 tracings                                                                                         | 10 tracings                    |
| DENSITY                | 1.53 - 1.55                                               | 1.51                                           | 1.58                                                                                                    | 1.39 - 1.50                    |
| PH                     | 8 / 9                                                     | 8 / 9                                          | 8 / 9                                                                                                   | 7.5 / 8.5                      |
| PIGMENT                | Titanium                                                  | Titanium                                       | Titanium                                                                                                | Organic                        |
|                        |                                                           |                                                |                                                                                                         |                                |
| ADDITIONAL INFORMATION | Perfect for training pitches or tracings of last minutes. | -                                              | -                                                                                                       | Available in 4 colours         |
| REFERENCE              | Reference: 060108                                         | Reference: 060084                              | Reference: 060142                                                                                       | Reference: 060099              |

READY-TO-USE PAINT



- Strong covering power
- No more dilution problems
- 1 can 10 L = 1 ground



GRASS IMPLANT



Available in 4 colours



Box of 25 implants + 1 dibble



Dual function dibble implant: you can sink or screw the implant



BLACK PARTS OF THE PRODUCT ARE 100% RECYCLED



Grass implants in synthetic fibre to signal the tracking of a line or an area on an ad hoc or permanent basis. Easy to install thanks to its dibble implant, you can either screw it if the ground is flexible or help you of a hammer if the ground is harder. 4 available colours: white, yellow, blue and red. Delivered per box of 25 implants of the same colour and a dibble implant tool.

- Reference: 060085 The box of 25 implants + dibble
- Reference: 060075 Unit tracking
- Reference: 060076 Dibble implant

High performance white tracing paint for synthetic and grass sports ground. Compatible with roller and spraying machine.

Reference: 060188 Unit



• SPRAY PAINT MARKING WHEELBARROW



| CAPACITY | WEIGHT |
|----------|--------|
| 8.5 L    | 12 kg  |

Pitch line marker with spray painting to have a width of tracing from 5 to 12 cm, for the tracing of grass pitches. Very manoeuvrable thanks to its low weight. Rubberised disc wheels of 26 cm diameter. Cleaning of the spray system after each use.

Reference: 060109 Unit

PAINT MARKING WHEELBARROW



| CAPACITY | WEIGHT |
|----------|--------|
| 12 L     | 19 kg  |

Paint marking wheelbarrow with a 12-liter tank. Easy to handle thanks to its inflatable pneumatic wheels, it features an integrated drainage system to simplify cleaning after use. Line width: 10 cm.

Reference: 060105 Unit

ODOMETER



CARRYING BAG

| Unfolded  |
|-----------|
| L. 102 cm |
| Folded    |
| L. 55 cm  |
| Wheel     |
| Ø 31.8 cm |



Retractable

RECYCLABLE  
WEIGHT  
2 kg

Foldable to facilitate the storage. Delivered with a carry bag. Features: measuring range from 0 to 99.999.9 m, resolution 0.1 m.

Reference: 024078 Unit

• PLOTTER TROLLEY CORD HOLDER



| Wheel    |
|----------|
| Ø 260 mm |

RECYCLED  
RECYCLABLE

To trace your outdoor grounds with a cord to guide the tracing of lines. Painted steel structure equipped with 2 cords of 200 m wound on plastic rollers with rewinding handle and 1 PVC tray with 12 metal pegs. Mounted on 2 never flat wheels. Retractable grab handle.

Reference: 060083 Unit

MEASURE TAPE



RECYCLABLE

Thermoplastic box with tape measure in fibreglass with centimetre and inch graduation.

|                   |       |
|-------------------|-------|
| Reference: 062737 | 10m.  |
| Reference: 062745 | 20m.  |
| Reference: 024051 | 30m.  |
| Reference: 024052 | 50m.  |
| Reference: 024053 | 100m. |

CHAUSS'PROPRE

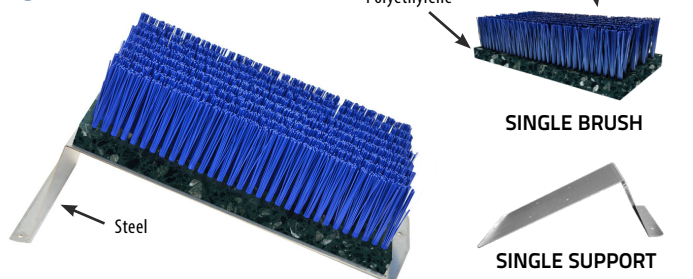

| Support |
|---------|
| 38.5 cm |

| Brush      |
|------------|
| w. 16.5 cm |
| L. 32 cm   |

RECYCLABLE

Wirehair brush on galvanized steel support that you can fix to the ground. Perfect for cleaning shoes before to return to the dressing room. Blue colour.

|                    |                |
|--------------------|----------------|
| Reference: 060119  | Unit           |
| Reference: 060119A | Single brush   |
| Reference: 060119B | Single support |

SET OF 4 RIGID CORNER POLES



| Pole |        | Flag |       |
|------|--------|------|-------|
| Ø    | 32mm   | w.   | 45 cm |
| L.   | 160 cm | L.   | 45 cm |



Required corner poles in rigid PVC with flags. Colours: red, white, yellow or checkered. Supplied with bag and sheaths, height 25 cm.

- Reference: 060178R Red
- Reference: 060178B White
- Reference: 060178J Yellow
- Reference: 060178D Checkered

SET OF 4 FLEXIBLE CORNER POLES



| Pole |        | Flag |       |
|------|--------|------|-------|
| Ø    | 32mm   | w.   | 45 cm |
| L.   | 180 cm | L.   | 45 cm |



Required corner poles in flexible PVC with flags. Articulated and secure system which allows the pole to fold up without danger. Colours: red, white, yellow or checkered. Supplied with bag and sheaths, height 30 cm.

- Reference: 060179R Red
- Reference: 060179B White
- Reference: 060179J Yellow
- Reference: 060179D Checkered

SET OF 4 ARTICULATED CORNER POLES



| Pole |        | Flag |       |
|------|--------|------|-------|
| Ø    | 32mm   | w.   | 45 cm |
| L.   | 180 cm | L.   | 45 cm |



Required corner poles in PVC tube with black articulated rubber connector and a fixed support to sink into the ground. Delivered with flag and bag. Colours: red, white, yellow or checkered.

- Reference: 060180R Red
- Reference: 060180B White
- Reference: 060180J Yellow
- Reference: 060180D Checkered
- Reference: 060082 PVC pole - single tube

FLAG FOR CORNER POLE



Flag with sheath system. Material: Polyester.

|            |       |
|------------|-------|
| Flag 32mmØ |       |
| w.         | 45 cm |
| L.         | 45 cm |

|            |       |
|------------|-------|
| Flag 40mmØ |       |
| w.         | 45 cm |
| L.         | 52 cm |

|                                    | RED         | CHECKERED   | YELLOW      | WHITE       |  |
|------------------------------------|-------------|-------------|-------------|-------------|--|
| Flag Tube Ø32 mm - 1.45 x L.45 cm. | Ref: 060177 | Ref: 060177 | Ref: 060177 | Ref: 060177 |  |
| Flag Tube Ø40 mm - 1.45 x L.52 cm. | Ref: 060116 | Ref: 060115 | Ref: 060116 |             |  |

SPARE PARTS FOR CORNER POLES

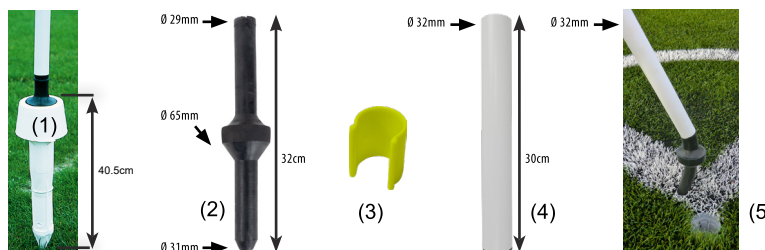

(1) Base which sinks into the ground for articulated pole. (2) Black articulated rubber connector (3) Clip allowing to hold the flag to the corner pole. Neon yellow colour. (4) Sheaths for corner poles Ø32 mm. (5) White PVC tube post only.

- Reference: 060080 PVC base (1)
- Reference: 060081 Connector (2)
- Reference: 060118 Locking clip (3)
- Reference: 060017 Sheaths for corner poles Ø32 mm (4)
- Reference: 060082 White PVC tube post only (5) - Ø32 mm, H. 150 cm.



FOOTBALL FOR 8 - TRAPEZOIDAL NETS

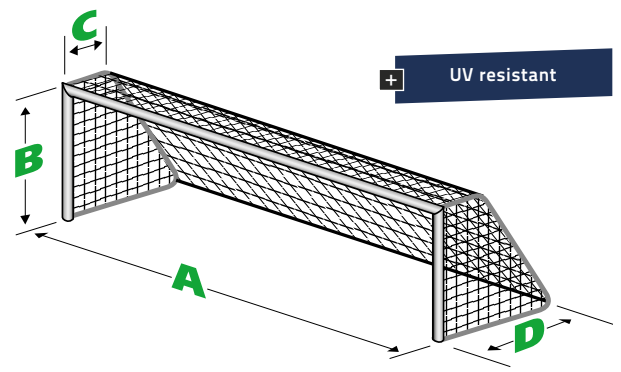

|                                          | Dimensions<br>A x B x C x D | Knotted or<br>knotless | Net type** | Twine size (mm) | Colours | Reference             |                       | Pair |
|------------------------------------------|-----------------------------|------------------------|------------|-----------------|---------|-----------------------|-----------------------|------|
|                                          |                             |                        |            |                 |         | 145 mm<br>square mesh | 120 mm<br>square mesh |      |
| <b>TRAPEZOIDAL SHAPE</b>                 |                             |                        |            |                 |         |                       |                       |      |
| GOAL TO BE<br>SEALED                     | 6 x 2.10 x 0.80 x 1.60 m    | Knotted                | Twisted PE | 2 mm<br>double  | ●       | Ref.065001            | -                     |      |
|                                          |                             | Knotted                | Braided PP | 3 mm<br>simple  |         |                       | Ref.065004            |      |
|                                          |                             | Knotted                | Braided PE | 3 mm<br>simple  |         | Ref.065123            | -                     |      |
| TRANSPORTABLE<br>GOAL<br>AND MOBILE GOAL | 6 x 2.10 x 0.87 x 2.03 m    | Knotted                | Braided PE | 3 mm<br>simple  |         | Ref.065069            | -                     |      |
|                                          |                             |                        |            |                 |         | Ref.065069U           | -                     |      |
| FOLDABLE GOAL                            | 6 x 2.10 x 0.60 x 1.60 m    | Knotted                | Braided PE | 3 mm<br>simple  |         | Ref.065009            | -                     |      |

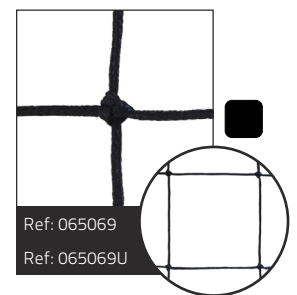
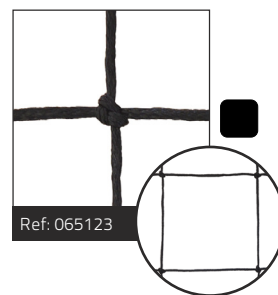
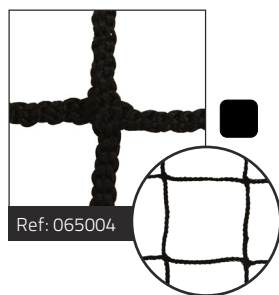
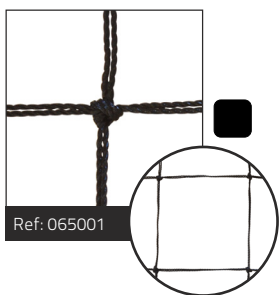

**Fitted cut** +

Net slightly shorter on the sides = specific dimension for folding goal.  
The net doesn't drag on the ground and doesn't wrap around the du roll.

\* Braided PE = braided polyethylene twine - Twisted PE = twisted polyethylene twine - PP = polypropylene



FOOTBALL FOR 11 - TRAPEZOIDAL NETS



Goal to be sealed



Transportable goal

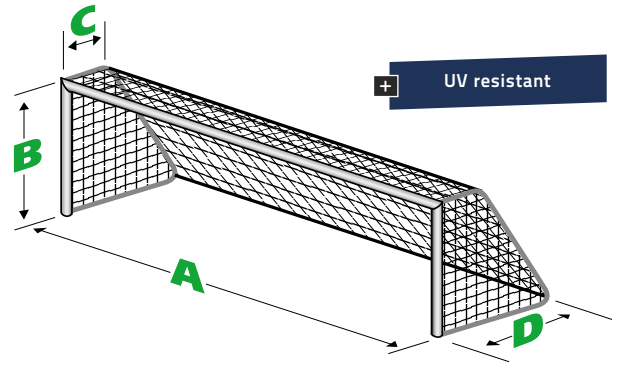

|                           | Dimensions<br>AxBxCxD    | Knotted or<br>knotless | Net type** | Twine size<br>(mm) | Colours            | Type of<br>use           | Reference             |                       | Pair   |
|---------------------------|--------------------------|------------------------|------------|--------------------|--------------------|--------------------------|-----------------------|-----------------------|--------|
|                           |                          |                        |            |                    |                    |                          | 145 mm<br>square mesh | 120 mm<br>square mesh |        |
| <b>FORME TRAPÉZOÏDALE</b> |                          |                        |            |                    |                    |                          |                       |                       |        |
| GOAL TO<br>BE SEALED      | 7.50 x 2.50 x 0.80 x 2 m | Knotted                | Braided PE | 3 mm<br>simple     | ● ○                | Training,<br>Competition | Ref.065104            | -                     |        |
|                           |                          | Knotless               | Braided PP | 3 mm<br>simple     | ● ○                | Training,<br>Competition | -                     | Ref.065005            |        |
|                           |                          | Knotless               | Braided PP | 4 mm<br>simple     | ● ● ● ●<br>● ● ● ● | Competition              | -                     | Ref.065116            |        |
| TRANSPORTABLE<br>GOAL     | 7.50x2.50x1x2 m          | Knotted                | Braided PE | 3 mm<br>simple     | ●                  | Training                 | Ref.065097            | -                     | (Unit) |

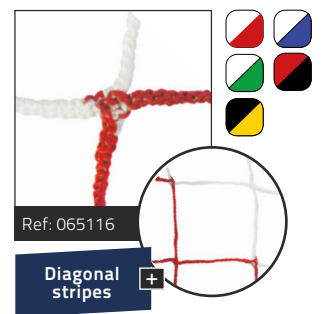
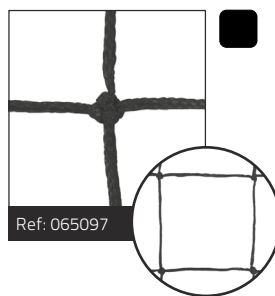
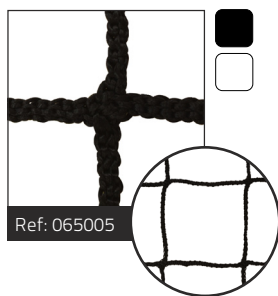
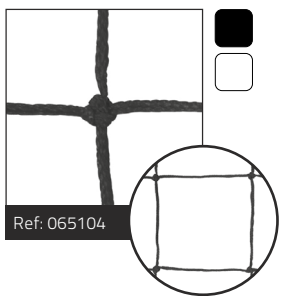

NETS ACCESSORIES:

25 M. STRAP ROLL / REF: 022008



- To fix the net on the goals.
- Bobbin of 25 m. red



SET OF 26 METAL PEGS / REF: 060146



- To fix the net on the field.

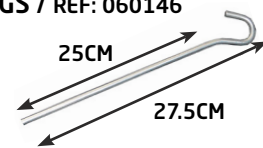

Set of 26

SANDOWS 10 MM Ø (SET OF 4)

- With buckles.
- Length: 50cm.



\* Braided PE = braided polyethylene twine - Twisted PE = twisted polyethylene twine - PP = polypropylene



FOOTBALL FOR 11 - EUROPEAN NETS

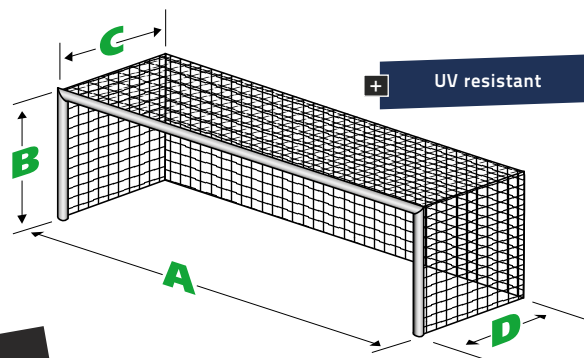

Goal to seal

|                         | Dimensions<br>AxBxCxD | Knotted<br>or<br>knotless | Net<br>type** | Twine size<br>(mm) | Colours | Type of<br>use | Reference             |                       | 120 mm<br>hexagonal<br>mesh | Pair |  |
|-------------------------|-----------------------|---------------------------|---------------|--------------------|---------|----------------|-----------------------|-----------------------|-----------------------------|------|--|
|                         |                       |                           |               |                    |         |                | 145 mm<br>square mesh | 120 mm<br>square mesh |                             |      |  |
| <b>FORME EUROPÉENNE</b> |                       |                           |               |                    |         |                |                       |                       |                             |      |  |
| GOAL TO<br>BE SEALED    | 7.50 x 2.50 x 2 x 2 m | Knotted                   | Braided PE    | 3 mm<br>simple     |         | Competition    | Ref.065209            | -                     | -                           |      |  |
|                         |                       |                           |               | 4 mm<br>simple     |         | Competition    | Ref.065109            | -                     | -                           |      |  |
|                         |                       |                           |               |                    |         | Competition    | -                     | Ref.065062            | -                           | -    |  |
|                         |                       | Knotless                  | Braided PP    | 4 mm<br>simple     |         | Competition    | -                     | Ref.065118            | -                           | -    |  |
|                         |                       |                           |               |                    |         | Competition    | -                     | -                     | Ref.065060<br>(Honeycomb)   |      |  |
|                         |                       |                           |               |                    |         | Competition    |                       |                       | Ref.065210<br>(Honeycomb)   |      |  |

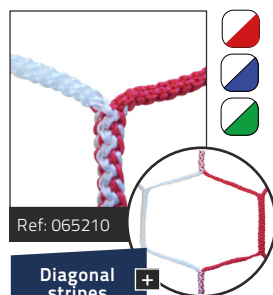
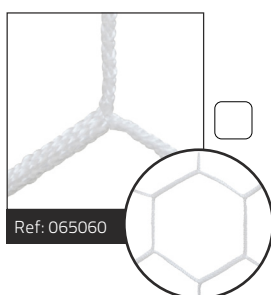
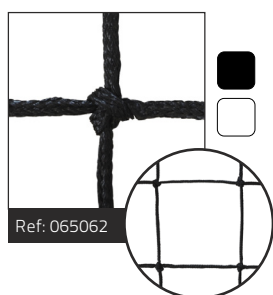
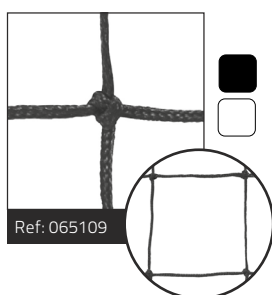
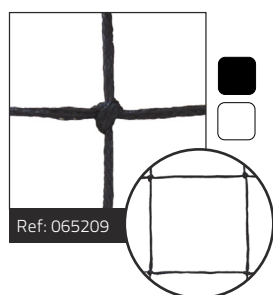

NETS ACCESSORIES:

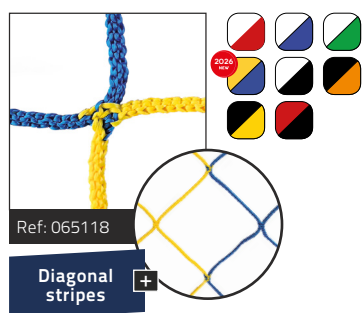

Ref: 065118

Diagonal stripes

\*\* Braided PE = braided polyethylene twine - Twisted PE = twisted polyethylene twine - PP = polypropylene

• HOOK FOR STEEL GOAL (WITH SCREW)



Hook very resistant. For steel goal with screw.

Ref: 060042 Unit

• HOOK FOR ALU GOAL



Hook very resistant. For aluminium goal.

Ref: 060043 Unit

• HOOK FOR ALU GOAL



Plastic hook for alu goal with a runner. Sold by the unit. Width: 3 cm. Height: 2 cm. Thickness: 0.91 cm.

Ref: 060041 Unit



TROLLEY TEAM BAG



100% polyester  
600 deniers  
reinforced



| 2 SIZES       |               |
|---------------|---------------|
| Ct: 59 Litres | Ct: 77 Litres |
| H. 30 cm      | H. 32 cm      |
| w. 32 cm      | w. 34 cm      |
| L. 61 cm      | L. 71 cm      |



100 % polyester bag reinforced 600 deniers for a greater resistance, large main compartment with a large U-shape opening with double zip, 2 side pockets and one pocket on the front face with a zip. With its casters and its retractable handle, this trolley becomes an excellent bag for player but also to transport equipment. A bag designed for clubs with an excellent value for money.

|                   |                        |       |                                         |
|-------------------|------------------------|-------|-----------------------------------------|
| Reference: 078113 | Size: 61cm / 59 Litres | Black | Dimensions: L. 61cm x h. 30cm x w. 32cm |
| Reference: 078114 | Size: 71cm / 77 Litres | Black | Dimensions: L. 71cm x h. 32cm x w. 34cm |

SPORTS BAG TEAM



| 3 SIZES       |               |               |
|---------------|---------------|---------------|
| Ct: 42 Litres | Ct: 58 Litres | Ct: 76 Litres |
| H. 28 cm      | H. 30 cm      | H. 32 cm      |
| w. 30 cm      | w. 32 cm      | w. 34 cm      |
| L. 50 cm      | L. 60 cm      | L. 70 cm      |



100% polyester  
600 deniers  
reinforced

100 % polyester bag reinforced 600 deniers, large main compartment with a large opening in U form with double zips, 2 lateral pockets and one pocket on the front face with a zip. Adjustable and removable padded strap. A bag designed for clubs with an excellent value for money.

|                   |                        |                                         |
|-------------------|------------------------|-----------------------------------------|
| Reference: 078110 | Size: 50cm / 42 Litres | Dimensions: L. 50cm x h. 28cm x w. 30cm |
| Reference: 078111 | Size: 60cm / 58 Litres | Dimensions: L. 60cm x h. 30cm x w. 32cm |
| Reference: 078112 | Size: 70cm / 76 Litres | Dimensions: L. 70cm x h. 32cm x w. 34cm |

EQUIPMENT BAG



2 separate inside compartments aerated thanks to their mesh



2 carry handles



| CAPACITY | LENGTH | WIDTH | HEIGHT |
|----------|--------|-------|--------|
| 102 L    | 77 cm  | 38 cm | 35 cm  |

\*1 customised logo. Our marked articles will be neither taken back nor exchanged.

100% polyester 1680D high quality and reinforced lining. Colour: Black.

Reference: 078049 Unit

BACKPACK



Padded straps and back

Openwork side pocket

Bimaterial



| CAPACITY | THICKNESS | WIDTH | HEIGHT |
|----------|-----------|-------|--------|
| 25 L     | 15 cm     | 30 cm | 44 cm  |

Backpack with large main compartment, 2 side mesh pockets and a large front zippered pocket for small accessories. Padded back and carrying straps for greater comfort. Material: polyester. Colour: black with reflective stripes on front.

Reference: 078002 Unit



CARRYING BALLS NET



Easy fastening with another colour cord

Braided net in polypropylene of 4mm diameter, simple mesh of 100 mm. Delivered without ball.

|                   |             |        |
|-------------------|-------------|--------|
| Reference: 078034 | 2/3 balls   | White  |
| Reference: 078035 | 5/6 balls   | Blue   |
| Reference: 078029 | 10/12 balls | Yellow |
| Reference: 078030 | 15/20 balls | Red    |

BALLS BAG



|                |
|----------------|
| Cap. 6-7 balls |
| H. 75 cm       |
| w. 40 cm       |

|                  |
|------------------|
| Cap. 12-15 balls |
| H. 90 cm         |
| w. 50 cm         |

Bag for balls in nylon canvas 600 deniers. It has a shoulder strap, a cord stopper and lateral ventilation net. Colour: Black. Delivered without ball.

|                   |                      |
|-------------------|----------------------|
| Reference: 078026 | Capacity 6-7 balls   |
| Reference: 078028 | Capacity 12-15 balls |

TROLLEY



| WEIGHT | LENGTH | WIDTH | HEIGHT |
|--------|--------|-------|--------|
| 22kg   | 61.5cm | 60 cm | 113 cm |

Whether for transporting balls or equipment, this trolley will be the ideal partner for your training. Very easy to handle and very practical with its front door and oversized wheels, you will have no trouble rolling it, even on grassy ground. Delivered disassembled.

Reference: 068009 Unit

JERSEY / SHORTS BAG



| LENGTH | WIDTH | HEIGHT |
|--------|-------|--------|
| 45 cm  | 35cm  | 22 cm  |

100% Polyester 600 deniers reinforced with PVC. Holds 14 jerseys and 14 shorts. With plastic pocket with label on the front, inside mesh pocket and carrying handle. Large U-shaped opening for easy storage. Black colour.

Reference: 078001 Unit

BALL BAG (1 BALL)



|                     |        |
|---------------------|--------|
| RECYCLED RECYCLABLE |        |
| DIAMETER            | HEIGHT |
| 26 cm               | 26 cm  |

Ball bag suitable for all types of balls, featuring a polyester fabric base with a 26 cm diameter and a polyester mesh section 26 cm high. Equipped with a small carabiner on the bottom of the bag and a large side carabiner on a strap, it can easily be attached to a backpack, for example, to make transport easier. An inside zippered fabric pocket measuring 22 x 13 cm allows you to store keys, documents, or other small accessories. Colour: Black.

Reference: 078020 Unit



**FOAM FOOTBALL**



**WEIGHT**  
210 g

**DIAMETER**  
22 cm

Foam ball in raw polyurethane.

Reference: 067305 Unit

**DYNAMIC FOAM FOOTBALL**



**WEIGHT**  
320 g

**DIAMETER**  
21 cm

RECYCLABLE

Foam football in high density polyurethane.

Reference: 067210 Unit

**INITIATION FOOTBALL**



**WEIGHT**  
315 g

**DIAMETER**  
21 cm

RECYCLABLE

Beginner football in flexible plastic which allows a long lifespan and flexibility. It can be used on all types of floor, including very hard (for example tarmac). Colour: Turquoise/Blue.

Reference: 067037 Unit

**UNITED FOOTBALL**



SIZE 3



SIZE 4



SIZE 5

Ball designed for training, very good price-quality ratio for this ball made with synthetic materials very flexible and resistant with its 4 layers. Available in 3 sizes: Size 3 (White / Blue), Size 4 (White / neon yellow) and Size 5 (White / Red).

Reference : 067319A

Size 3 - Unit

Reference : 067319B

Size 4 - Unit

Reference : 067319C

Size 5 - Unit

**BEACH SOCCER BALL**



**WEIGHT**  
380 g

**DIAMETER**  
20 cm

Specially adapted for sand game to resist abrasion while remaining flexible.

Reference: 067320 Size 5

**FUTSAL BALL**



**WEIGHT**  
400/440 g

**DIAMETER**  
20 cm

Training futsal ball, hand-stitched and shiny, designed for an intensive use on all types of floor. Synthetic materials very flexible and resistant. It rebounds 3 times when it is thrown at a height of 1 m. Official circumference 62/64cm.

Reference : 067291 Unit

**INDOOR FOOTBALL**



SIZE 5

SIZE 4

Traditional indoor football, 32 pannels hand-stitched. Felt coating, latex bladder. It can be used on all types of indoor floor (except abrasive like tarmac). Its composition allows to have a classic rebound.

Reference: 067289 Size 4

Reference: 067289 Size 5

**CECIFOOT BALL AND TORBALL**



SIZE 3



SIZE 5

**WEIGHT**  
450 g

**DIAMETER**  
19 cm

Official Torball with low rebound and with bells inside allowing a person who is partially sighted or blind to locate it when it is rolling. Practice place: inside and outside. Material: polyurethane. Official size and weight. Available in 2 sizes.

Reference: 067016A Size 3

Reference: 067016B Size 5



COMPRESSOR



| RECYCLED<br>RECYCLABLE |         |         |         |
|------------------------|---------|---------|---------|
| WEIGHT                 | LENGTH  | WIDTH   | HEIGHT  |
| 3.7 kg                 | 25.5 cm | 13.5 cm | 20.5 cm |

Electric compressor with integrated pressure gauge, on / off switch, pressure regulator and air filter. Delivered with its hose and its inflation nozzles. Power supply: 220 - 240 V / 50 Hz. Maximum pressure: 4 Bars.

Reference: 063137

TANK COMPRESSOR



| WEIGHT  | LENGTH | WIDTH | HEIGHT |
|---------|--------|-------|--------|
| 10.5 kg | 34 cm  | 32 cm | 36 cm  |

Portable compressor with 6L tank and pressure up to 8 bars. Compact and light, it comes with a 5m spiral hose, an inflation gun with pressure gauge and inflation accessory. Power supply: 220V.

Reference: 064502

Unit

PORTABLE COMPRESSOR



| WEIGHT | LENGTH | WIDTH | HEIGHT  |
|--------|--------|-------|---------|
| 8 kg   | 38 cm  | 14 cm | 39.5 cm |

Portable professional mini-compressor with a power of 1100W. With its 8 bars of pressure, it releases up to 160L/min. Sold with all the tips allowing you varied uses. Equipped with a quick connector, it comes with a pressure gauge gun. Its weight, dimensions and handle allow it to be moved easily.

Reference: 064501 Unit

DOUBLE ACTION HAND PUMP



Supplied with a hose and a needle for balls. Pump in both directions for a faster inflation.

Reference: 063270

PRESSURE GAUGE



Stainless pressure gauge to control the pressure of your balls. Rubber shock protection and decompression system with a push-button. Graduation with pressure indicator perfect per sport.

Reference: 063010

SET OF 12 STEEL NEEDLE FOR BALLS



European Model



Reference: 062993

WIRELESS COMPRESSOR



|              |        |        |       |        |
|--------------|--------|--------|-------|--------|
| Ultra light! | WEIGHT | LENGTH | WIDTH | HEIGHT |
|              | 330 g  | 13 cm  | 4 cm  | 8 cm   |

Light and compact, it fits in the palm of your hand and becomes the ideal partner for your bike rides or your outdoor training. Comes with a ball pump needle and adapter. Max pressure 7.5 bar. 2200mAh high capacity rechargeable Li-ion battery.

Reference: 063015

WIRELESS MULTI-USE COMPRESSOR



Wireless multi-use compressor, it is suitable for an effective inflation of balls, adjustment and reading of the pressure in Psi or Bar. It works with battery (9.6 V - 10 Bars pressure) or can be directly connected on the cigarette lighter of a car (12 V). Power: 180 W. Battery: 11.1 V. Supplied with ball and bike adapters.

Reference: 063007

GLYCERIN



| VOLUME |
|--------|
| 20 ml  |

Reference: 063009





**SPORTi  
FRANCE**



**BROWSE THIS CATALOGUE ONLINE  
BY SCANNING THIS QR CODE**



**AND FIND OUR FOOTBALL SELECTION  
ON SPORTIFRANCE.COM**



Photos and articles descriptions can be provided for information purposes only and not constitute at all a contractual document.  
Images credits: categories pages: Adobe Stock, ISTOCK and Sportifrance. / Products visuals: Suppliers, partners and Sportifrance. - Conception / Realisation : Sportifrance  
Catalogue published by Sportifrance, ZI Le Pironnet, 85120 La Châtaigneraie, France. SIRET: 50425070500036 / RCS 504 250 705 in La Roche sur Yon  
The reproduction of this catalogue, is prohibited without prior authorization from the author.

© Sportifrance - 2026